

Quantum Chaos and Scrambling: Recent Developments

Brian Swingle (UMD)

July 10

STRINGS 2019 Brussels

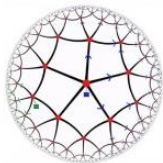

It from Qubit
Simons Collaboration on
Quantum Fields, Gravity and Information



**PHYSICS
FRONTIER
CENTER**
JOINT QUANTUM INSTITUTE



The Butterfly Effect.



by
J.L. Westover

www.mrlovenstein.com

What is quantum chaos?

- Classical chaos: “deterministic randomness”, ...
- Quantum chaology [**Berry**]: quantum signatures of classical chaos, semi-classical limit gives big Hilbert space, focused on “single-particle” systems
 - Quantum chaotic with regular classical limit [**Rozenbaum-Bunimovich-Galitski**]
- Quantum chaos: “deterministic **quantum** randomness”?, ...
 - Sensitivity: thermalization, echoes, quantum analogue of butterfly effect?
 - Randomness: random matrix-like energy level statistics, effective randomness in energy eigenstates
 - Complexity: growth of circuit complexity, complexity of eigenstates

Context: complexity/entanglement frontier

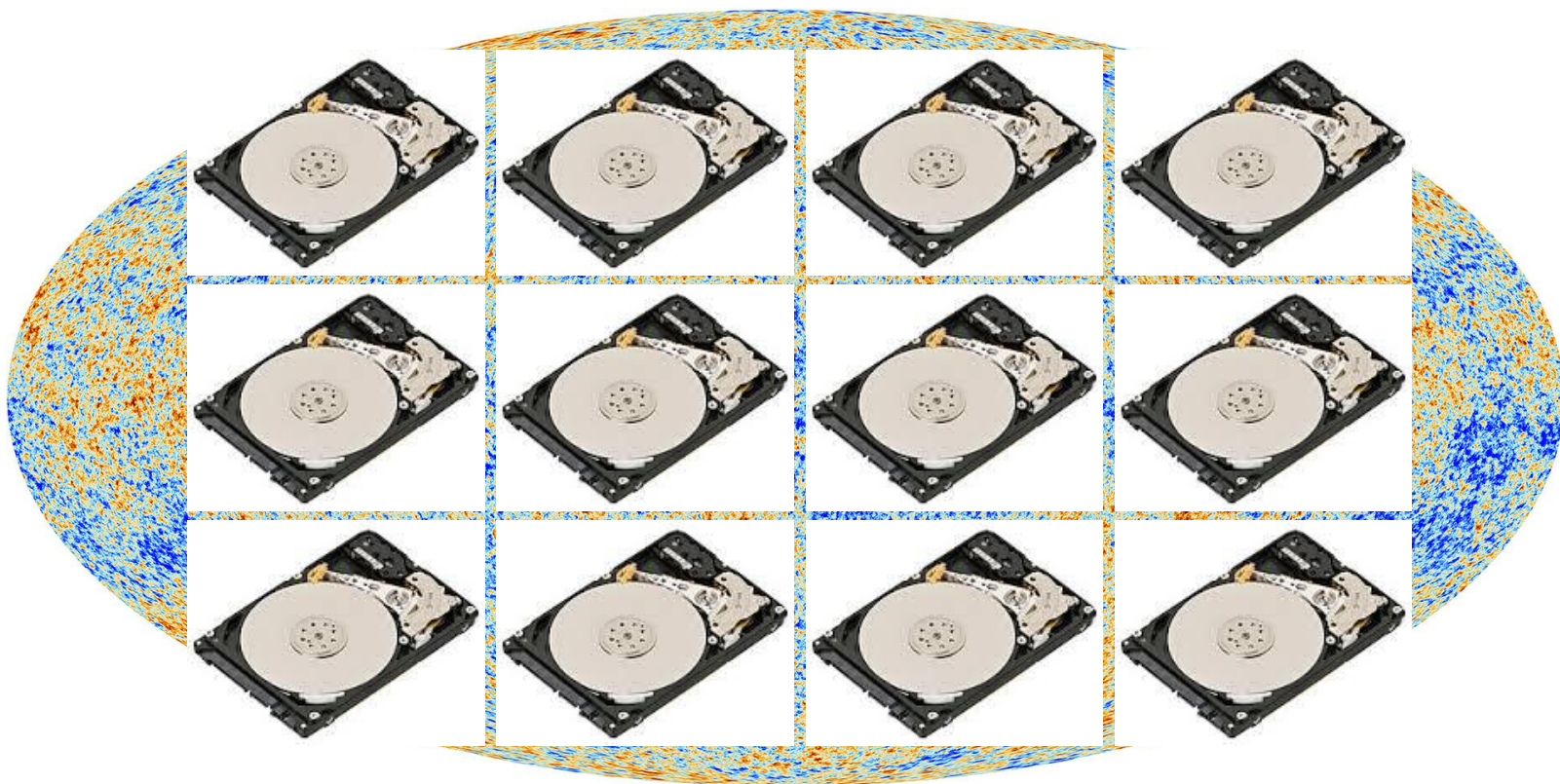

Fill universe with hard drives $\approx 10^{97}$ bits
→ Sufficient only for a few hundred spins

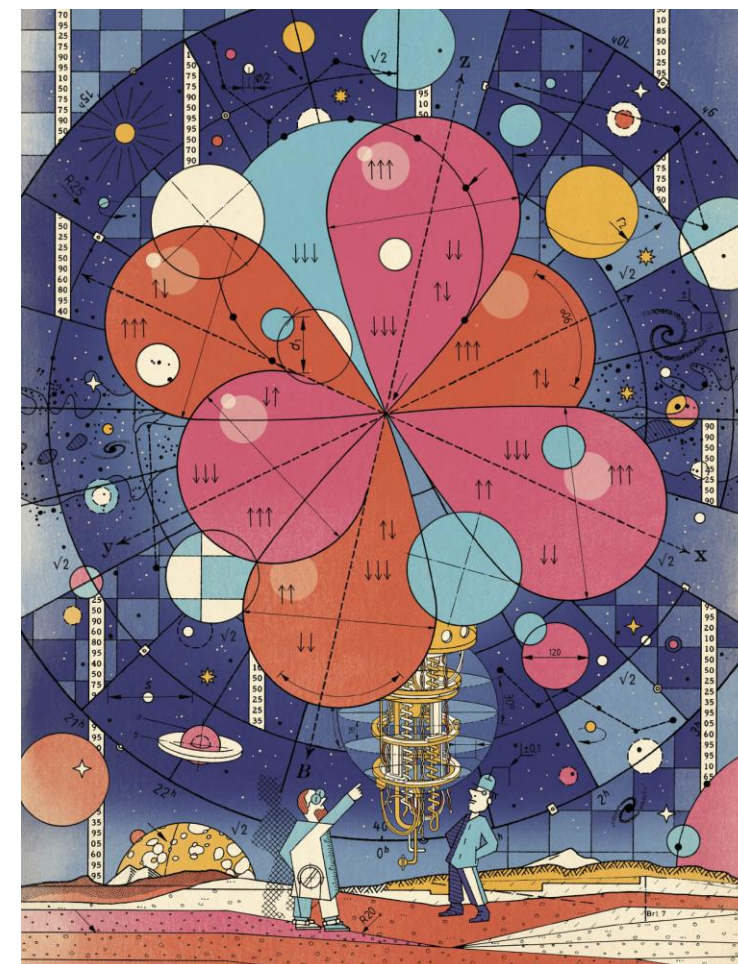

[Art by Christian Gralingen]

Timescales

- Entropy S measures effective system size
- Local

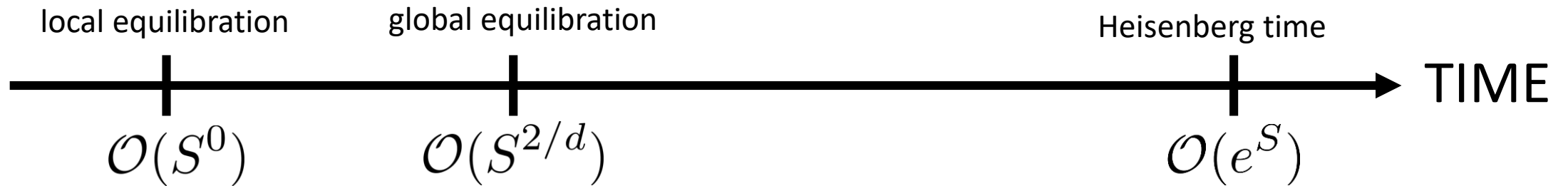

- Non-local

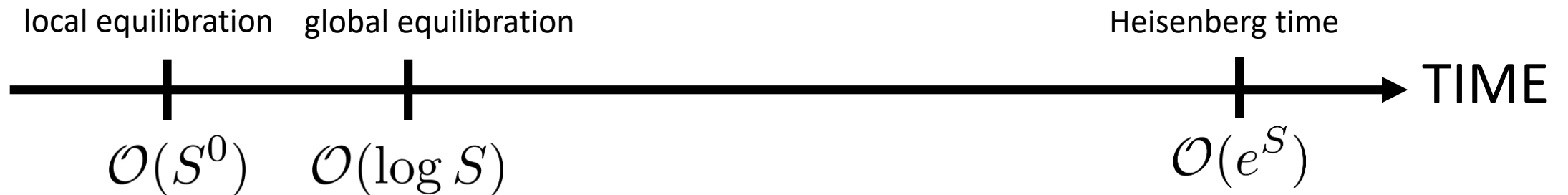

Fine print: not to scale, details matter, multiple notions of equilibration, symmetry and long-time tails, ...

Short times/coarse-grained

PARADÖX

play table and chair

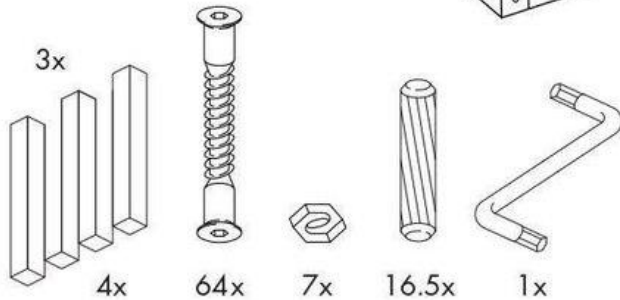
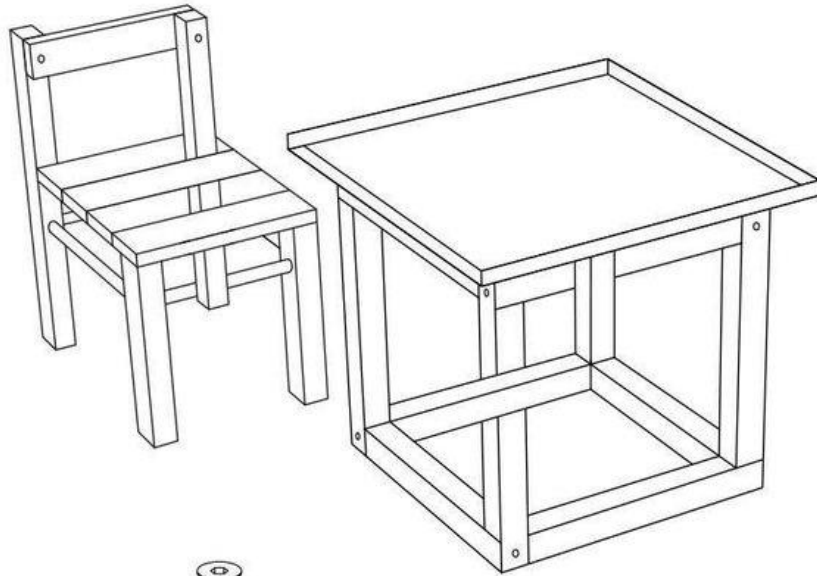

34

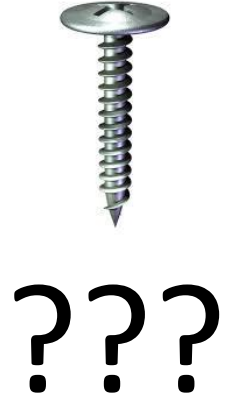
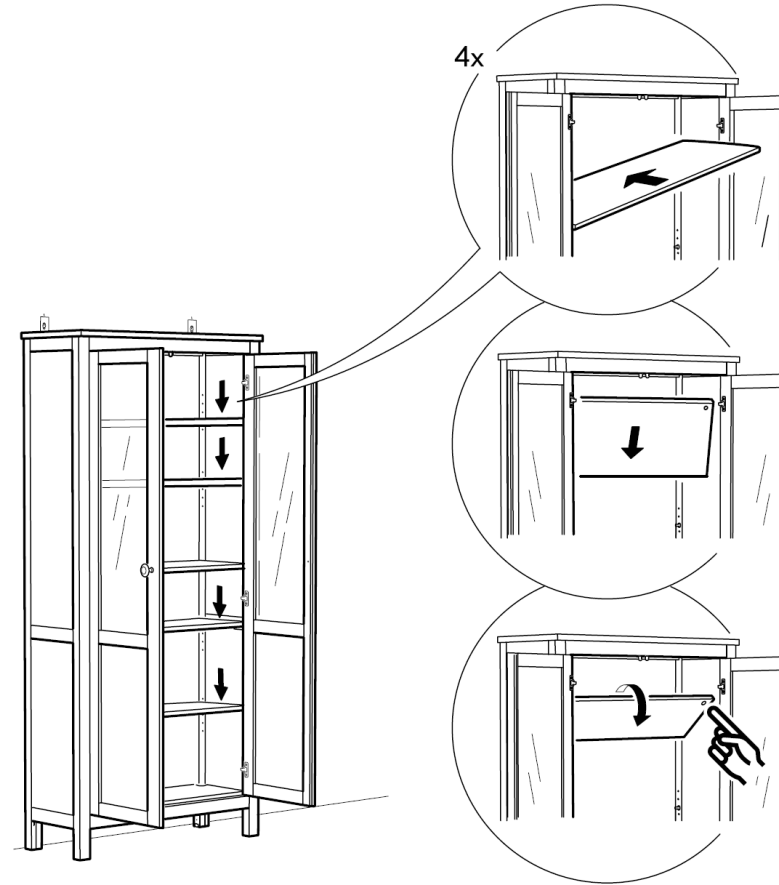

Missed a screw in step 2!
Fix: deconstruct back to
step 2, add screw, rebuild

Spacetime diagram of qubits interacting with neighbors

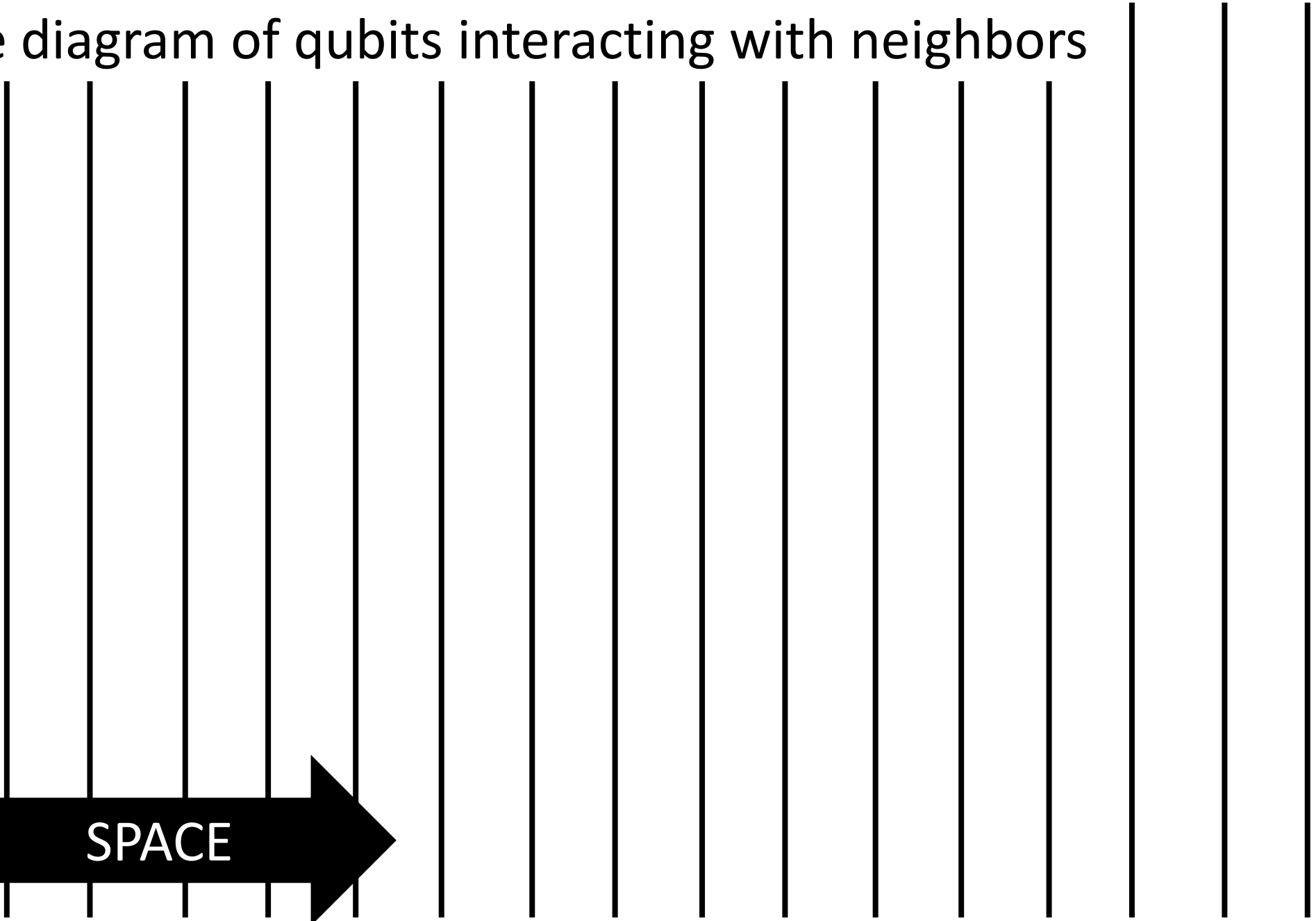
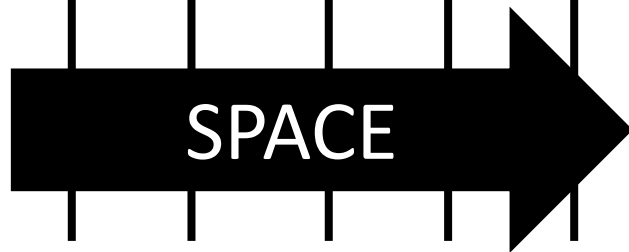
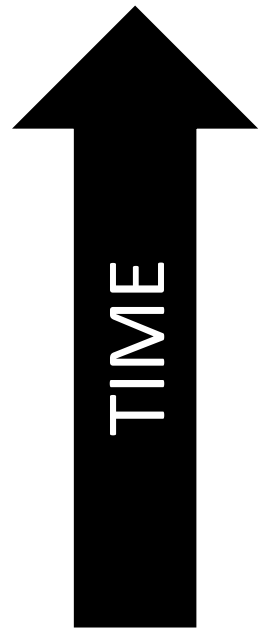

FORWARD

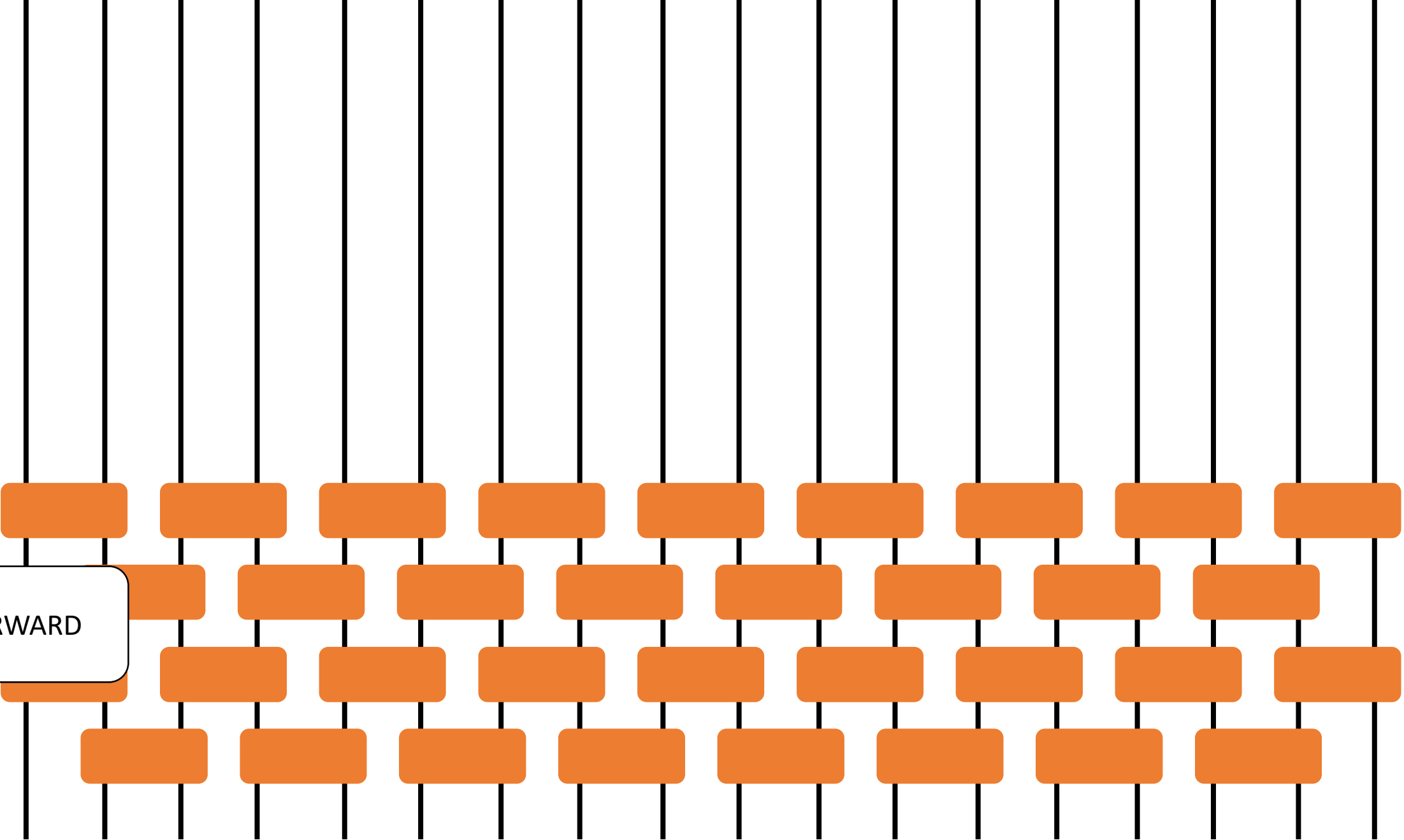

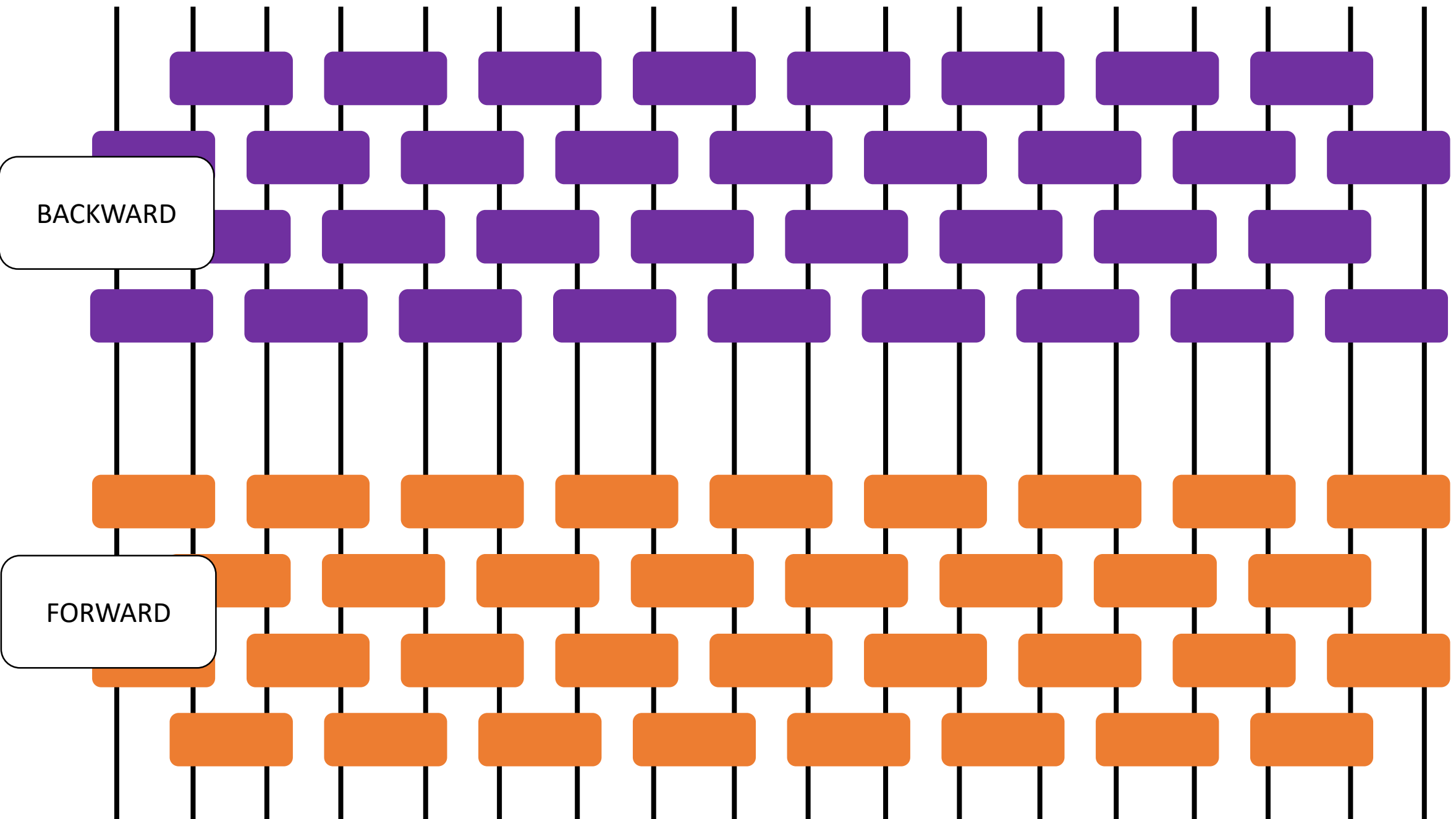

BACKWARD

FORWARD

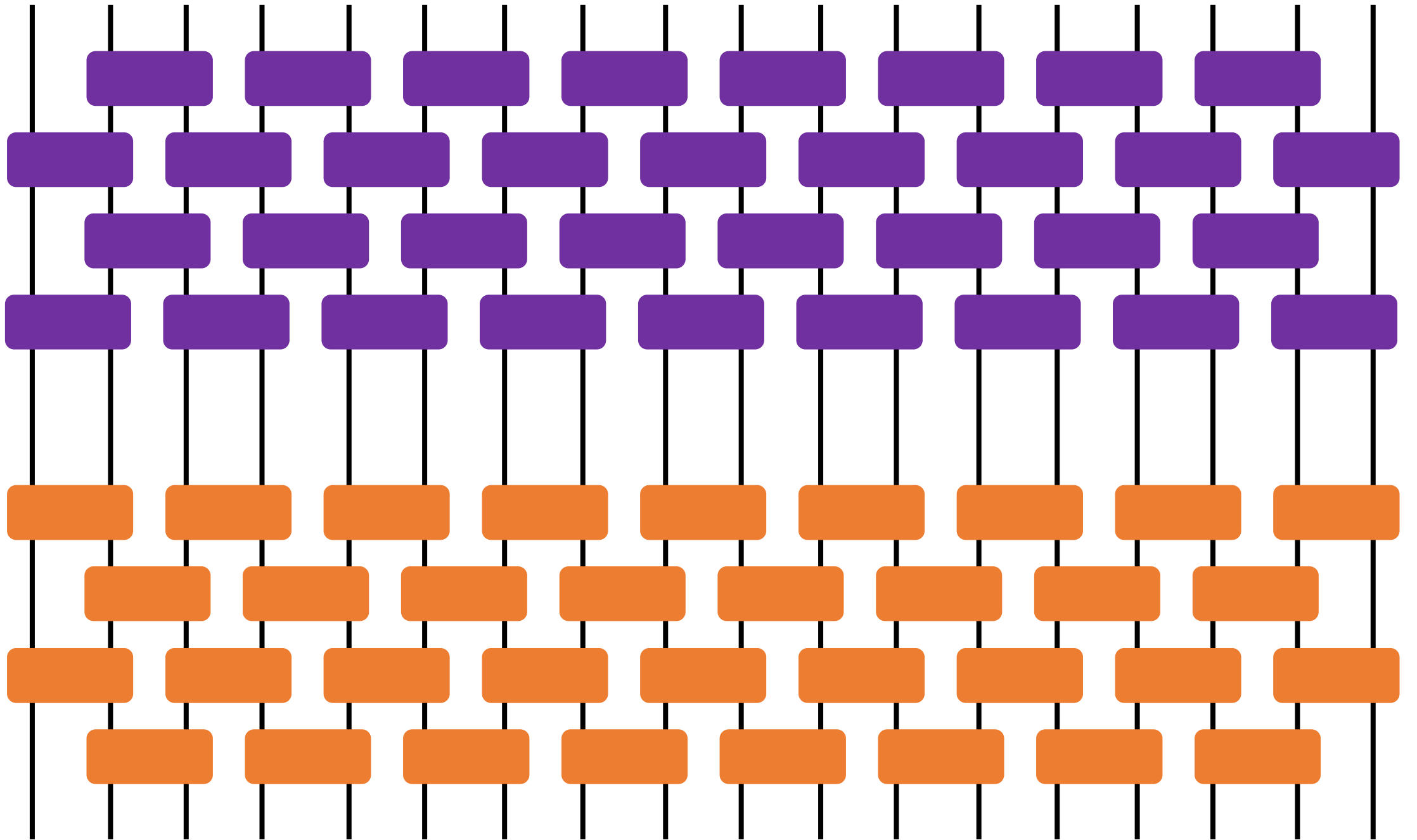

Snapshots of qubits with all-to-all interactions

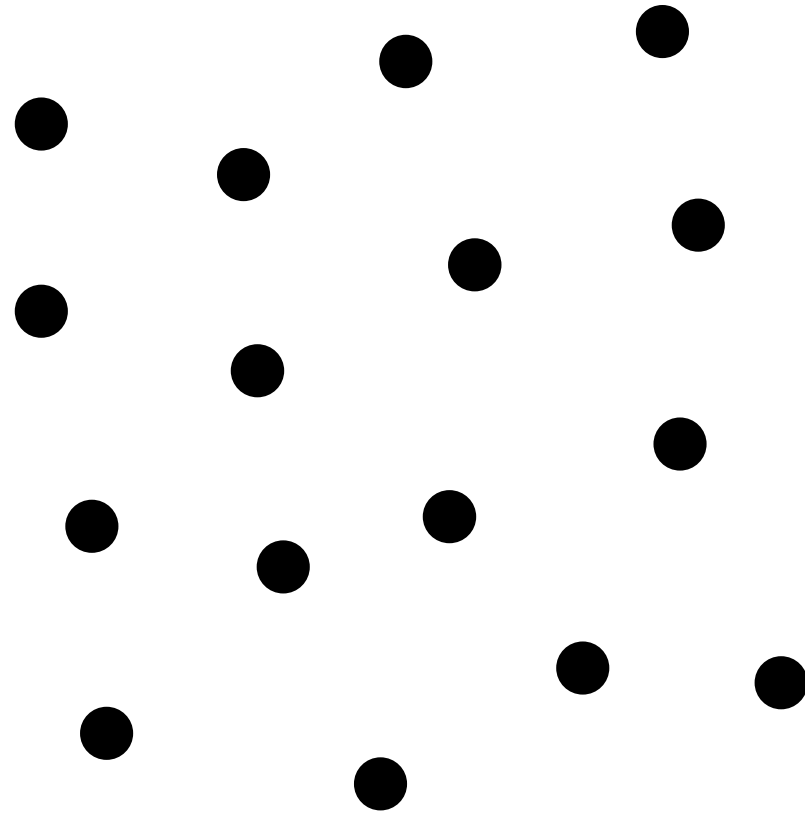

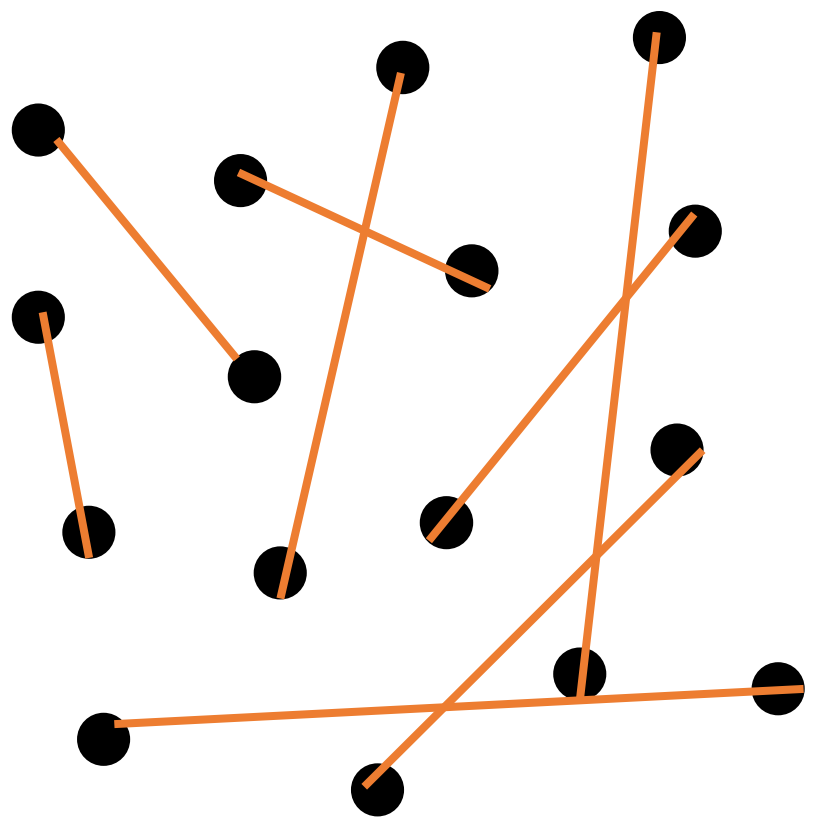

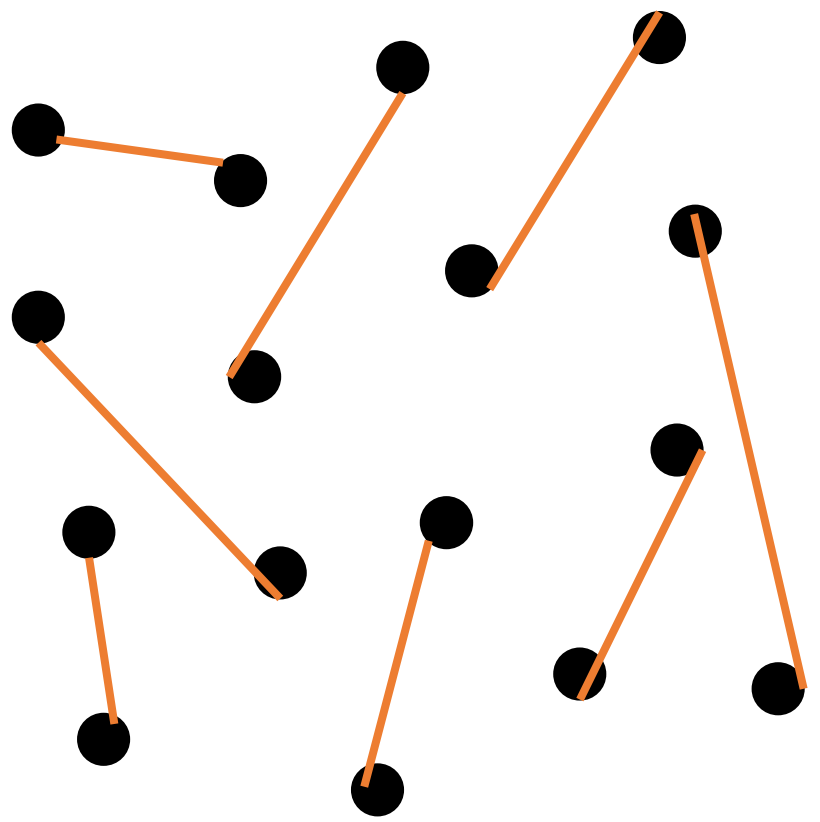

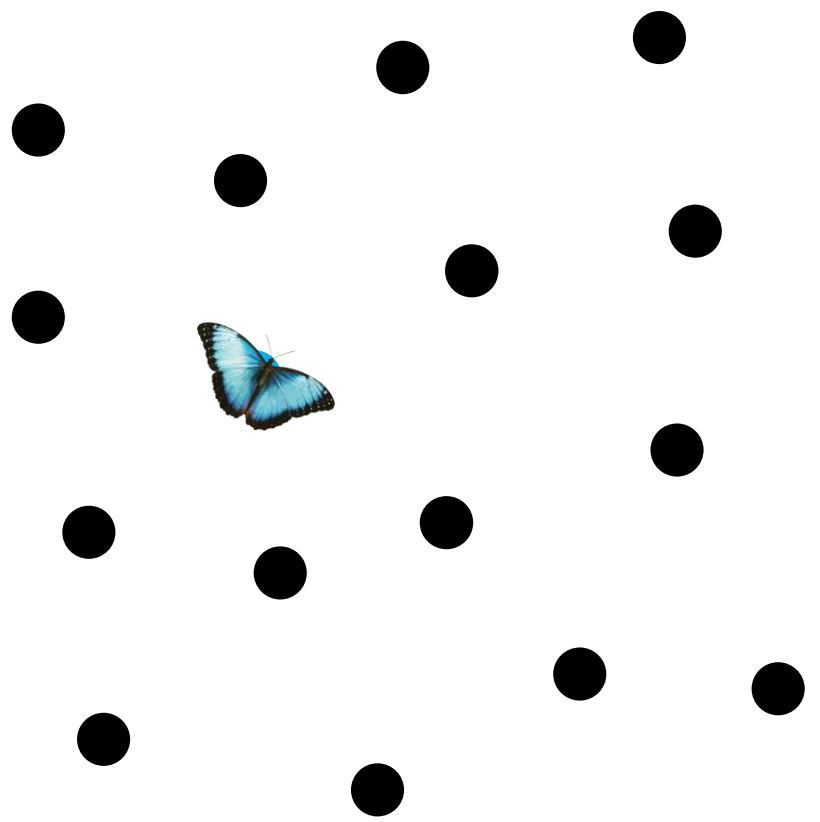

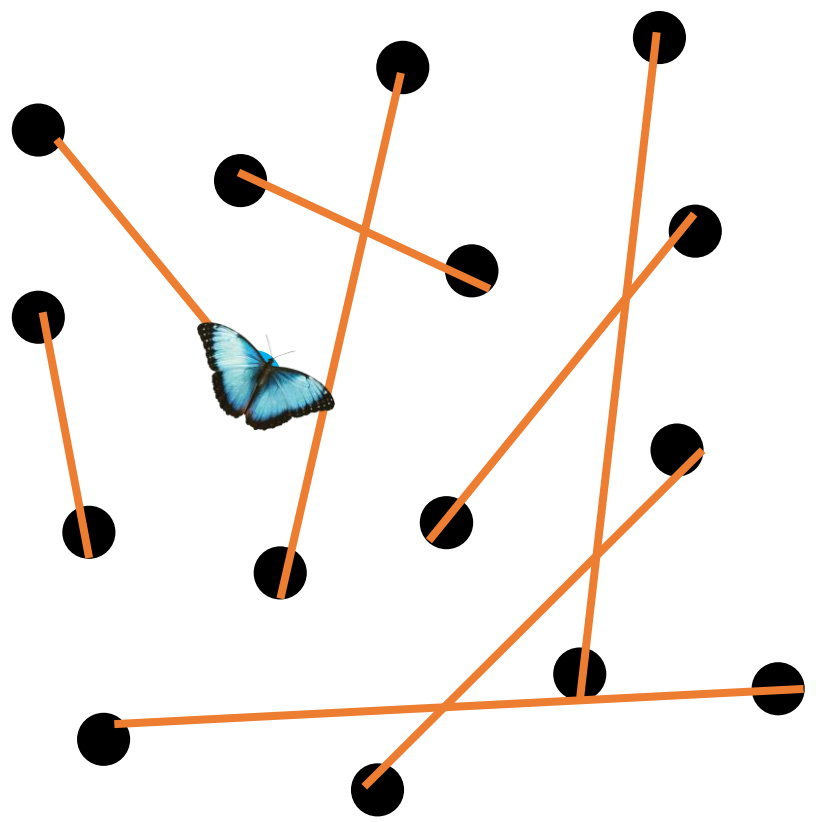

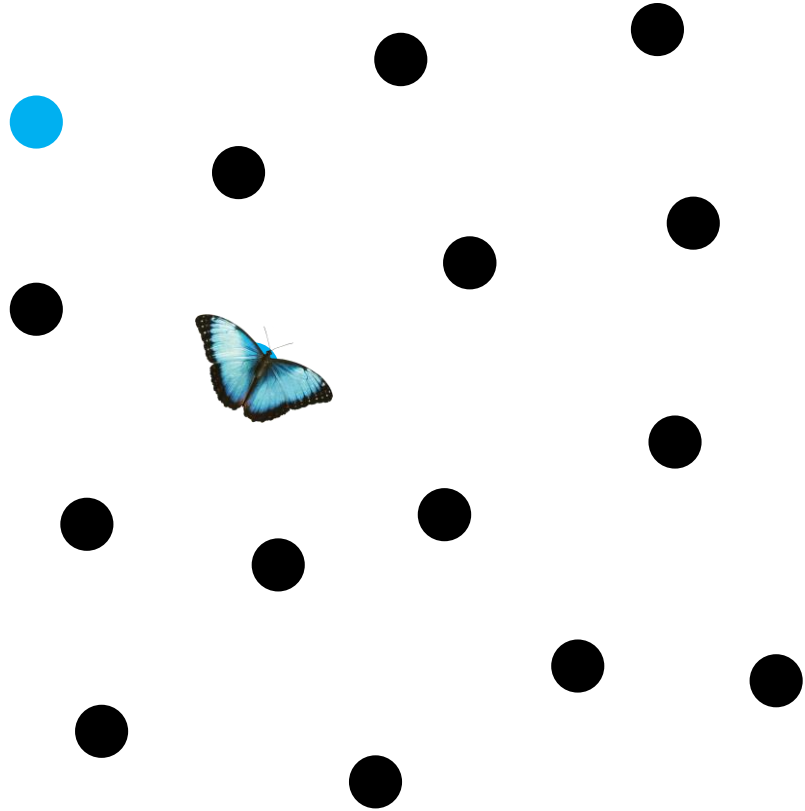

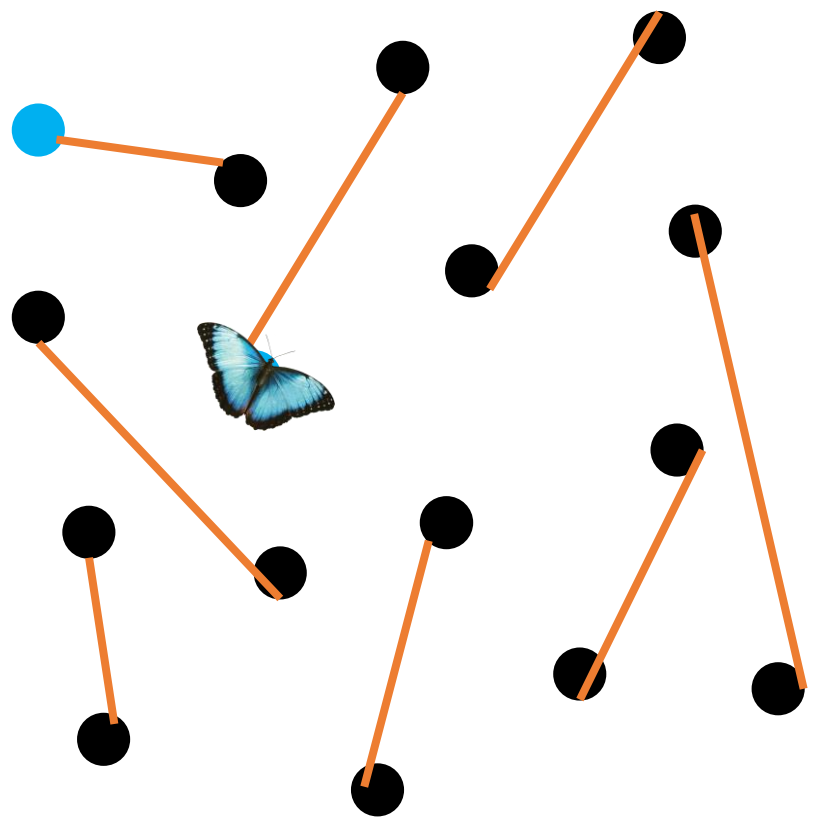

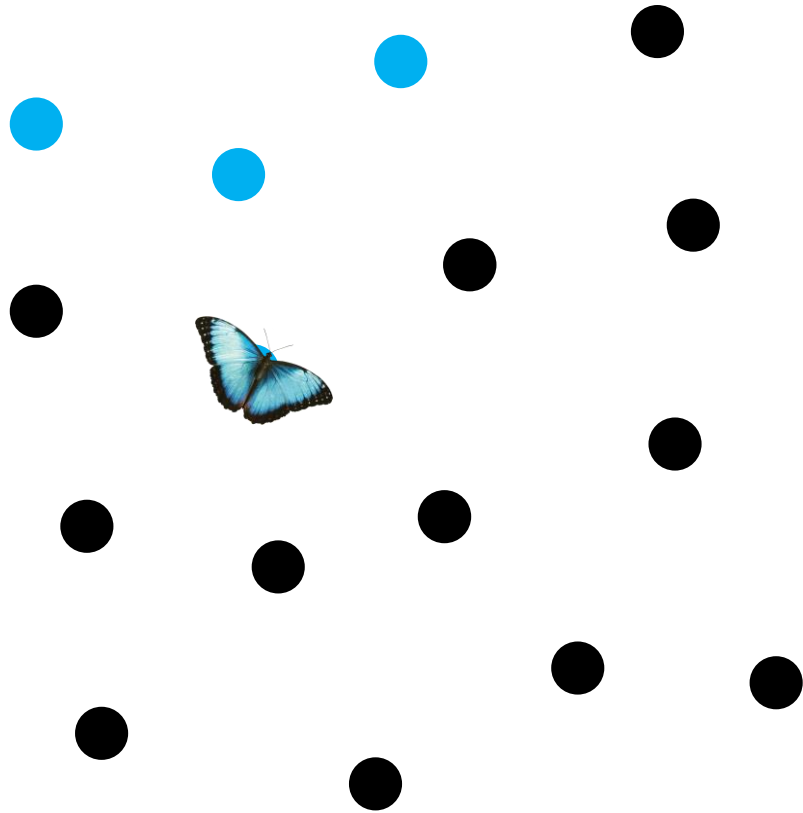

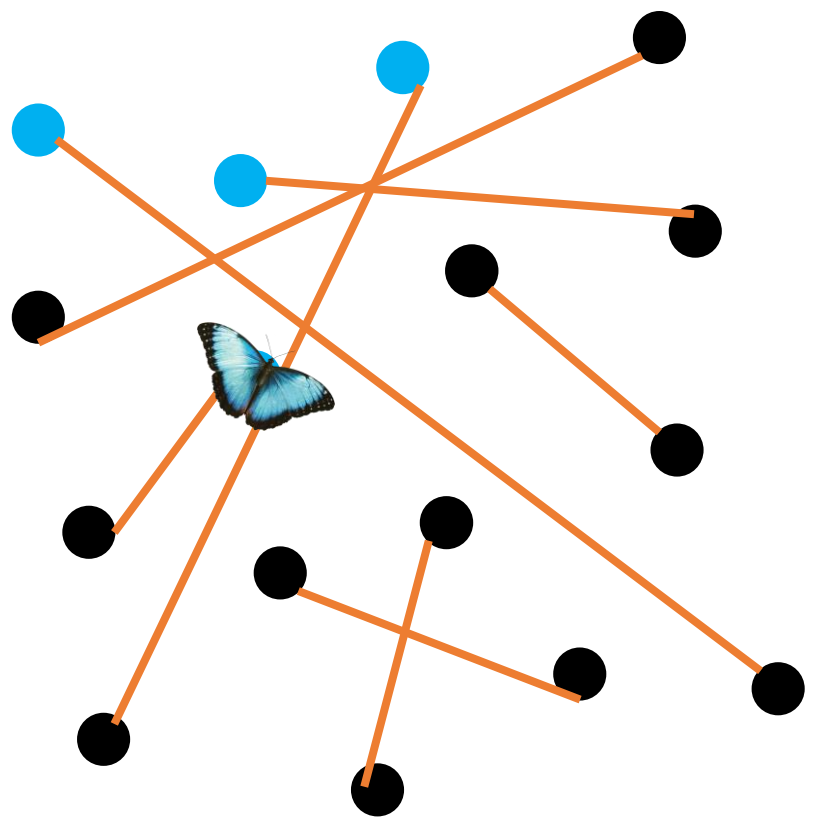

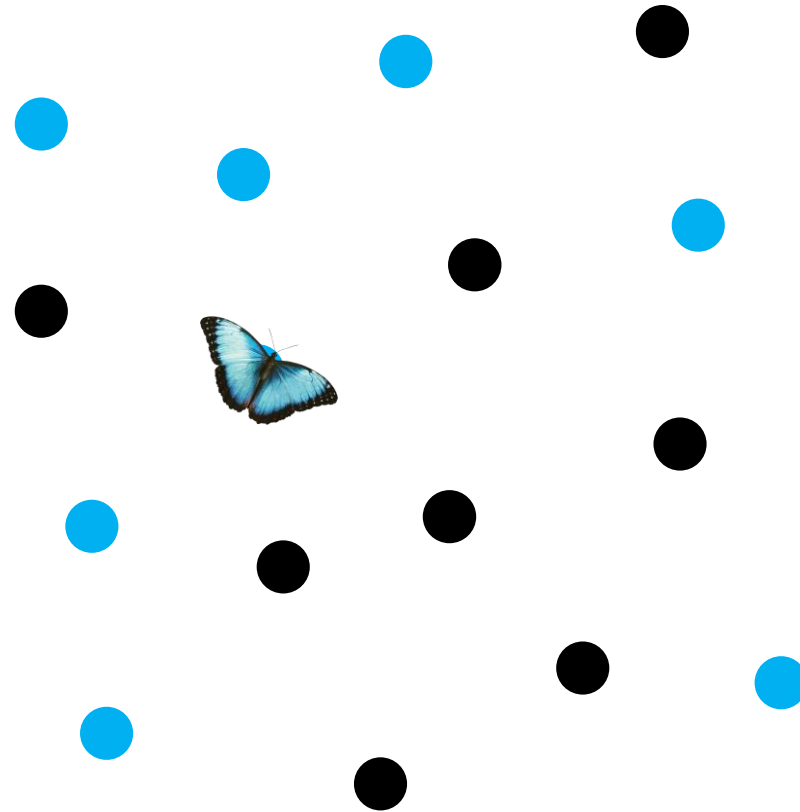

Affected region doubles every time step ...

Commutators

- Study dynamics in a highly excited state

$$G_R = -i \langle \psi | [W(t), V] | \psi \rangle$$

system thermalizes, loses
memory of initial condition:

$$G_R \rightarrow -i \text{Tr}(\rho_T [W(t), V]) = 0$$

- Can better probe the growth of $W(t)$ by studying the squared commutator:

$$C(t) = \langle [W(t), V]^\dagger [W(t), V] \rangle_T$$

Commutators, chaos, and black holes

- Semiclassical limit $V = e^{iq/a}, W = e^{ip/b}$

$$\langle [q_t, p] \rangle \approx i\hbar \{q_t, p\}_{\text{PB}} = i\hbar \frac{\partial q_t}{\partial q} = i\hbar e^{\lambda_L t}$$

[Larkin-Ovchinnikov 1968]

- Black hole chaos (AdS/CFT)

$$C \sim c_1 \frac{e^{2\pi T t}}{S} + c_2 \frac{e^{4\pi T t}}{S^2} + \dots \quad \text{early time, saturation later}$$

[Shenker-Stanford '13, Kitaev '14,
Maldacena-Shenker-Stanford]

Two classes (at least)

$$(C \ll 1)$$

1. Large N models (AdS/CFT, SYK, O(N))

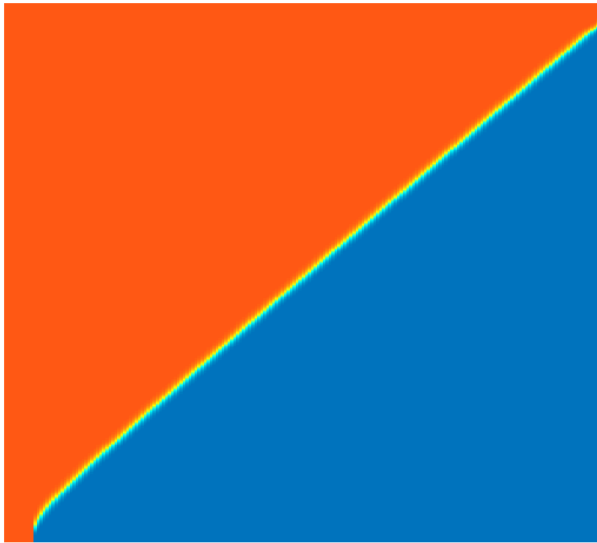

$$C \sim \frac{1}{N_{\text{dof}}} e^{\lambda(t-x/v_B)} + \dots$$

[e.g. Gu-Qi-Stanford *JHEP* 125 (2017).
Chowdhury-S *Phys. Rev. D* 96, (2017)
Xu/S arXiv:1805.05376]

2. Random unitary circuit model

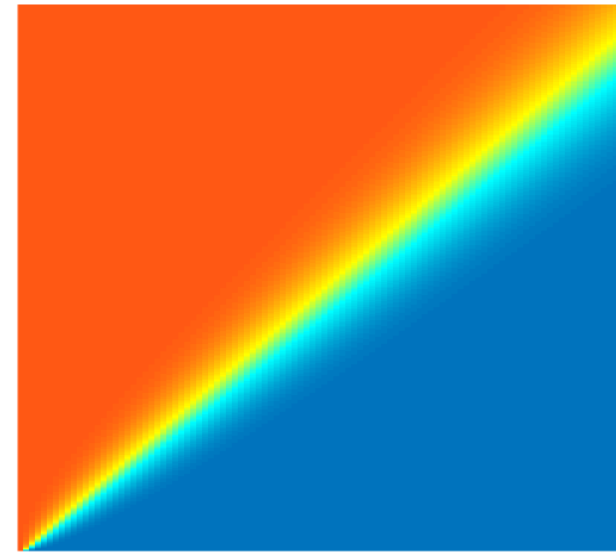

$$C \sim \text{erf} \left(\frac{x-v_B t}{\sqrt{Dt}} \right)$$

[Nahum/Haah/Vijay, Keyserlingk/Rakovszky/Pollman/Sondhi,
see also: follow up work with symmetries Khemani et al.]

General early growth form

$(C \ll 1)$

$$C(r, t) \sim \exp\left(-\lambda \frac{(r - v_B t)^{1+p}}{v_B (v_B t)^p}\right)$$

[Xu/S arXiv:1802.00801,
also: Khemani/Huse/Nahum 1803.05902]

□ $p = 0$: Semi-classical/Large N/holographic duality

□ Sharp wavefront

□ $p = 1$: Random circuit models

□ Diffusively broadened wavefront

□ Other models fit into this framework, e.g. non-interacting

Model: Brownian coupled clusters

$$O(t) = \sum a(\sigma_1, \sigma_2, \dots, \sigma_L) \sigma_1 \sigma_2 \dots \sigma_L$$

$$\tilde{h}(\mathbf{w}) = D(\mathbf{w}) \overline{|a|^2} \quad C(r, t) \sim \frac{w(r, t)}{N}$$

On-site

$$\partial_t \tilde{h} = \sum_r \left[-\gamma_r^+(w) \tilde{h}(\mathbf{w}) + \gamma_r^+(w+1) \tilde{h}(\mathbf{w} + \mathbf{e}_r) \right] + \left[-\gamma_r^-(w) \tilde{h}(\mathbf{w}) + \gamma_r^-(w-1) \tilde{h}(\mathbf{w} - \mathbf{e}_r) \right]$$

Bond

$$+ \sum_{\langle rr' \rangle} \left[-\gamma_b^+(w_r, w_{r'}) \tilde{h}(\mathbf{w}) + \gamma_b^+(w_r+1, w_{r'}) \tilde{h}(\mathbf{w} + \mathbf{e}_r) \right] + \left[-\gamma_b^-(w_r, w_{r'}) \tilde{h}(\mathbf{w}) + \gamma_b^-(w_r-1, w_{r'}) \tilde{h}(\mathbf{w} - \mathbf{e}_r) \right] + [r \longleftrightarrow r']$$

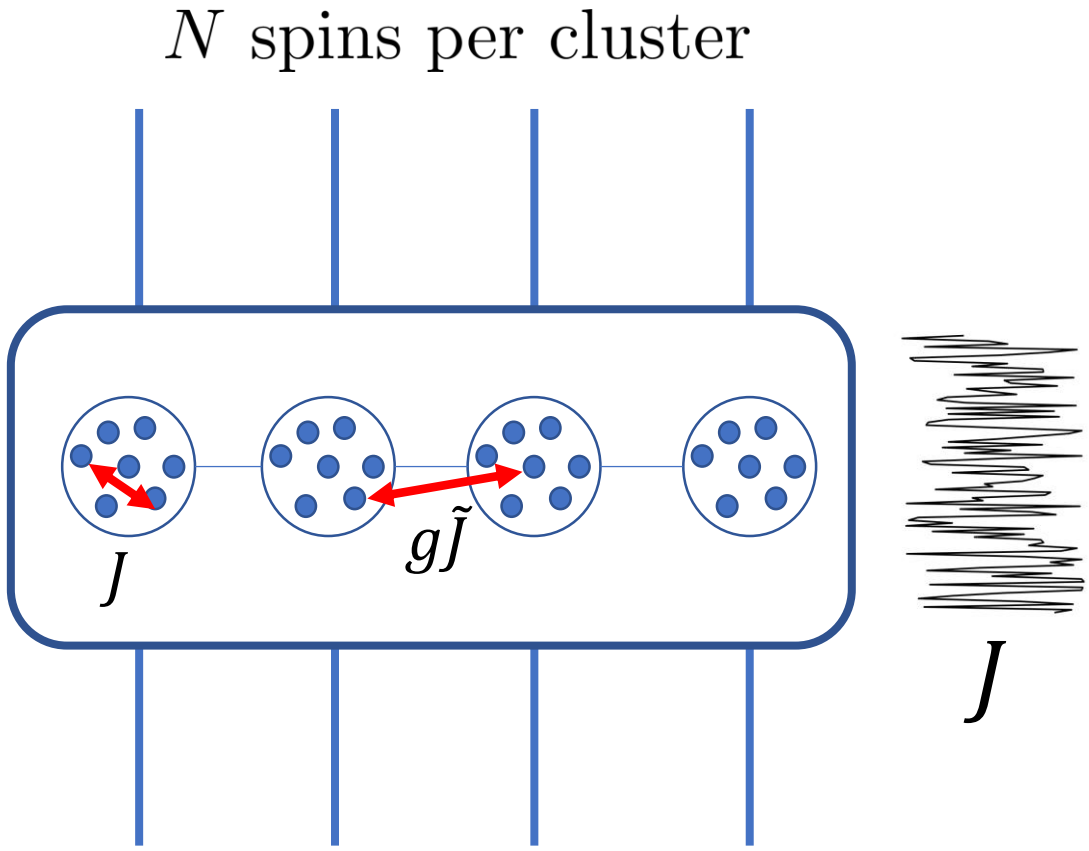

[Xu-S 1805.05376, results for single SYK cluster: Roberts-Streicher-Stanford]

Infinite N:

$$\partial_t C = (2 - C) \left(\frac{v_B^2}{\lambda_L} \partial_r^2 C + \lambda_L C \right)$$

Fisher-Kolmogorov-Petrovsky-Piskunov (FKPP) type equation

[FKPP (without noise) in other models: Faro/Ioffe/Aleiner, Chowdhury/S, Aavishkar/Chowdhury/S/Sachdev,...]



Large N:

$$\partial_t C = (2 - C)(\partial_r^2 C + C) + f_{noise}$$

Quantum fluctuations produce diffusive broadening

$$f_{noise} \sim \sqrt{\frac{C}{N}} \eta(r, t) \rightarrow D \sim \frac{1}{\log^3 N} \quad [\text{Brunet-Derrida-Mueller-Munier '06}]$$

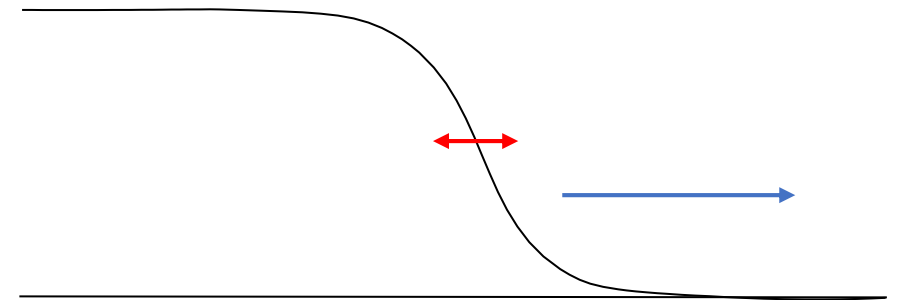

Spin chains: low entanglement outside front

$$H = -J \sum_r \sigma_r^z \sigma_{r+1}^z - h_x \sum_r \sigma_r^x - h_z \sum_r \sigma_r^z$$

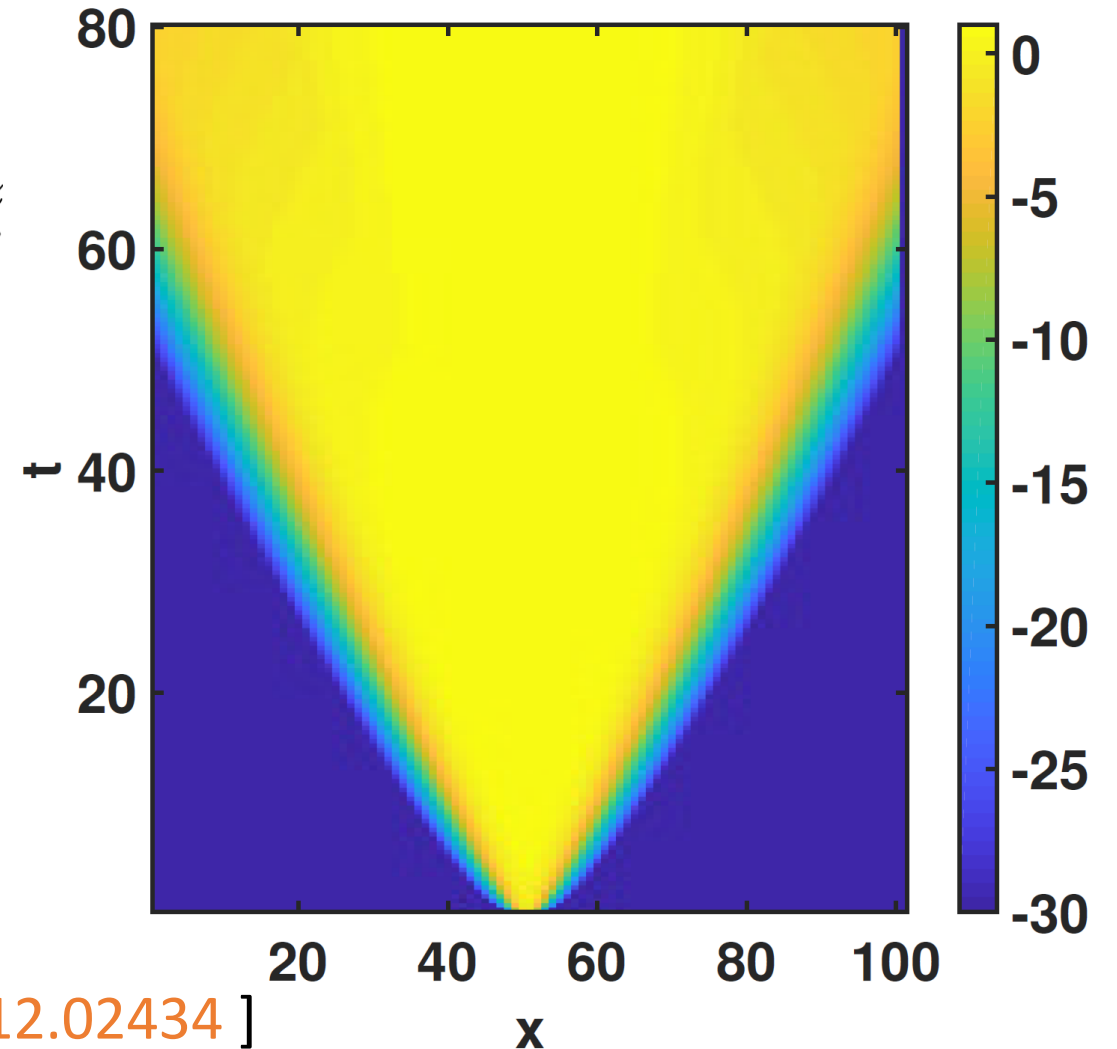
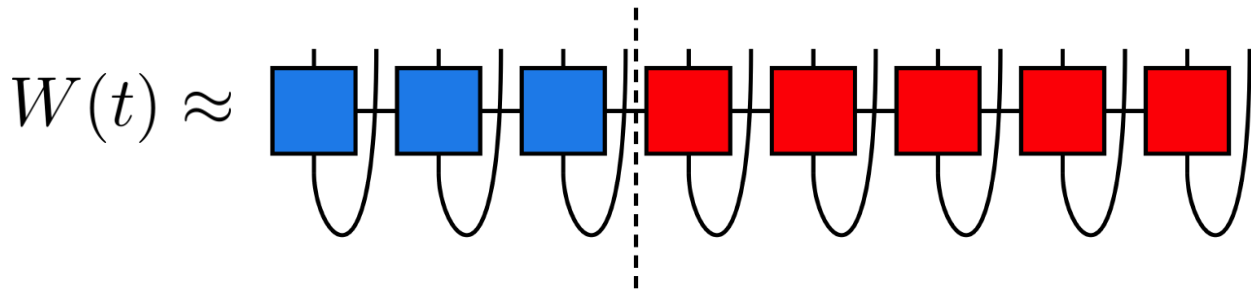

[Xu/S arXiv:1802.00801, see also: Bohrdt et al 1612.02434]

Constant C contours

$$C(x, t) = \exp\left(-\lambda \frac{(x - vt)^{1+p}}{v(vt)^p}\right)$$

$$x(t) = vt + \left(\frac{v}{\lambda} (vt)^p \log C\right)^{\frac{1}{1+p}}$$

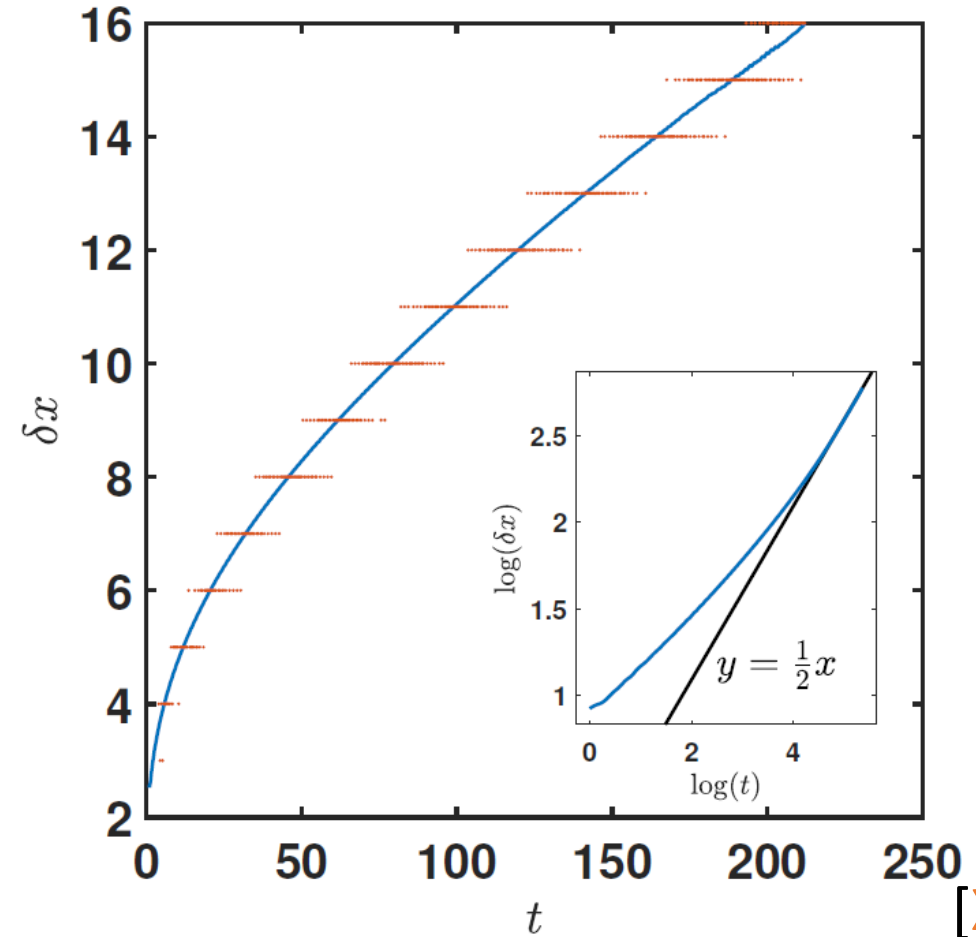
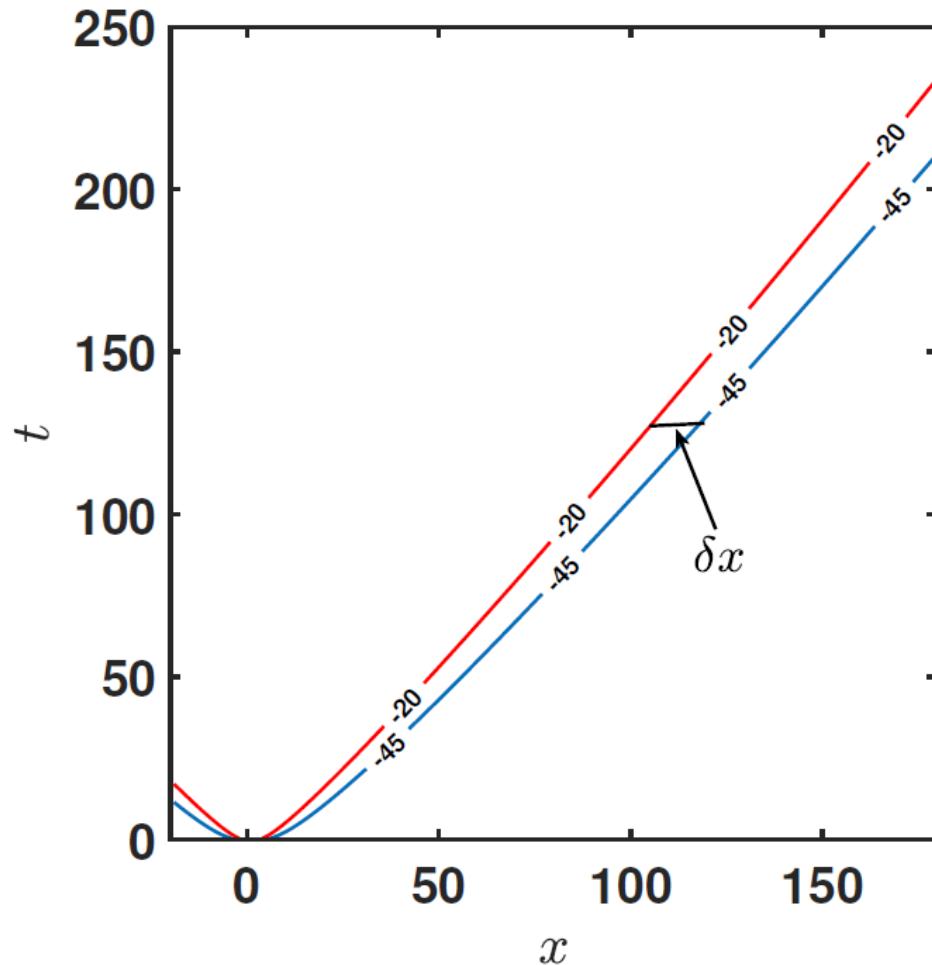

Other results

- Special structure of OTOCs obtained from ladder diagrams [[Gu-Kitaev](#)]
- Many results on spatially coupled SYK clusters (strange metals)
- Many calculations of OTOCs in model systems; ongoing work of operator growth dynamics including finite temperature [[Streicher-Qi](#)]
- Emergent slow dynamics in disordered systems [[Sahu-Xu-S, Xu-Li-Hsu-S-Das Sarma](#)]
- Lanczos approach and universal operator growth [[Parker et al.](#)]
- Regulator dependence of OTOC: different chaos exponents depending on operator placement around thermal circle [[Liao-Galitski, Romero-Bermudez-Schalm-Scopelliti](#)]

Long times/fine-grained

Energy levels and random matrix statistics

- Given a Hamiltonian H , there is an ordered list of energies $\{E_n\}$
- Key idea: energies are distributed as if they were the eigenvalues of a random Hermitian matrix of appropriate symmetry (at least in the “dense” part of the spectrum) [[Berry-Tabor](#), [Bohigas-Giannoni-Schmit](#)]
- Distribution of level spacings approximated by Wigner’s surmise
- Spectral form factor:

$$Z(\beta) = \sum_n e^{-\beta E_n}$$

$$K_1(t) = \overline{Z(\beta + it)}$$

$$K_2(t) = \overline{Z(\beta + it)Z(\beta - it)}$$

$$K_{2,c}(t) = K_2 - |K_1|^2$$

Exact calculations of spectral form factor

- Calculations in SYK and JT gravity [[Saad-Shenker-Stanford](#)]
- Calculations in a controlled lattice model [[Bertini-Kos-Prosen](#)]
 - Floquet dynamics

$$U = \exp \left(iJ \sum_r \sigma_r^z \sigma_{r+1}^z + i \sum_r h_r \sigma_r^z \right) \exp \left(ib \sum_r \sigma_r^x \right)$$

- Many remarkable properties for special values of J and b (and any h) including maximal entanglement growth and exactly linear spectral form factor
- Calculations use transfer matrix technology

Relations to other measures?

- Eigenstate thermalization hypothesis: eigenstates look thermal except for a small random-like component
 - Expected to coincide with chaos but precise relation is not clear
 - Partial argument showing ETH implies chaos bound [[Murthy-Srednicki](#)]
- Complexity growth
 - Eigenstate complexity hypothesis leads to exponentially long-lived local minimum [[Balasubramanian-DeCross-Kar-Parrikar](#)]
- Other manifestations of random matrix behavior:
 - Quantum Lyapunov spectrum and 2-pt function decay spectrum exhibit random-matrix-like level spacings [[Gharibyan-Hanada-Tezuka-S](#)]

Do systems localize?

- Many-body localization: random disorder (or other mechanisms) arrest thermalization; energy spectrum is Poisson-like
- Despite a more-or-less proof of the existence of MBL in an Ising spin chain [Imbrie '14], little truly controlled information is available
- Recent study of spectral form factors suggests MBL may not truly exist as an asymptotic phenomenon [Suntajs-Bonca-Prosen-Vidmar]
 - Thouless time would scale exponentially with disorder strength, but would ultimately remain well below Heisenberg time in thermodynamic limit
 - Small size numerical claim; not tested on the model with proven MBL

Quantum scars

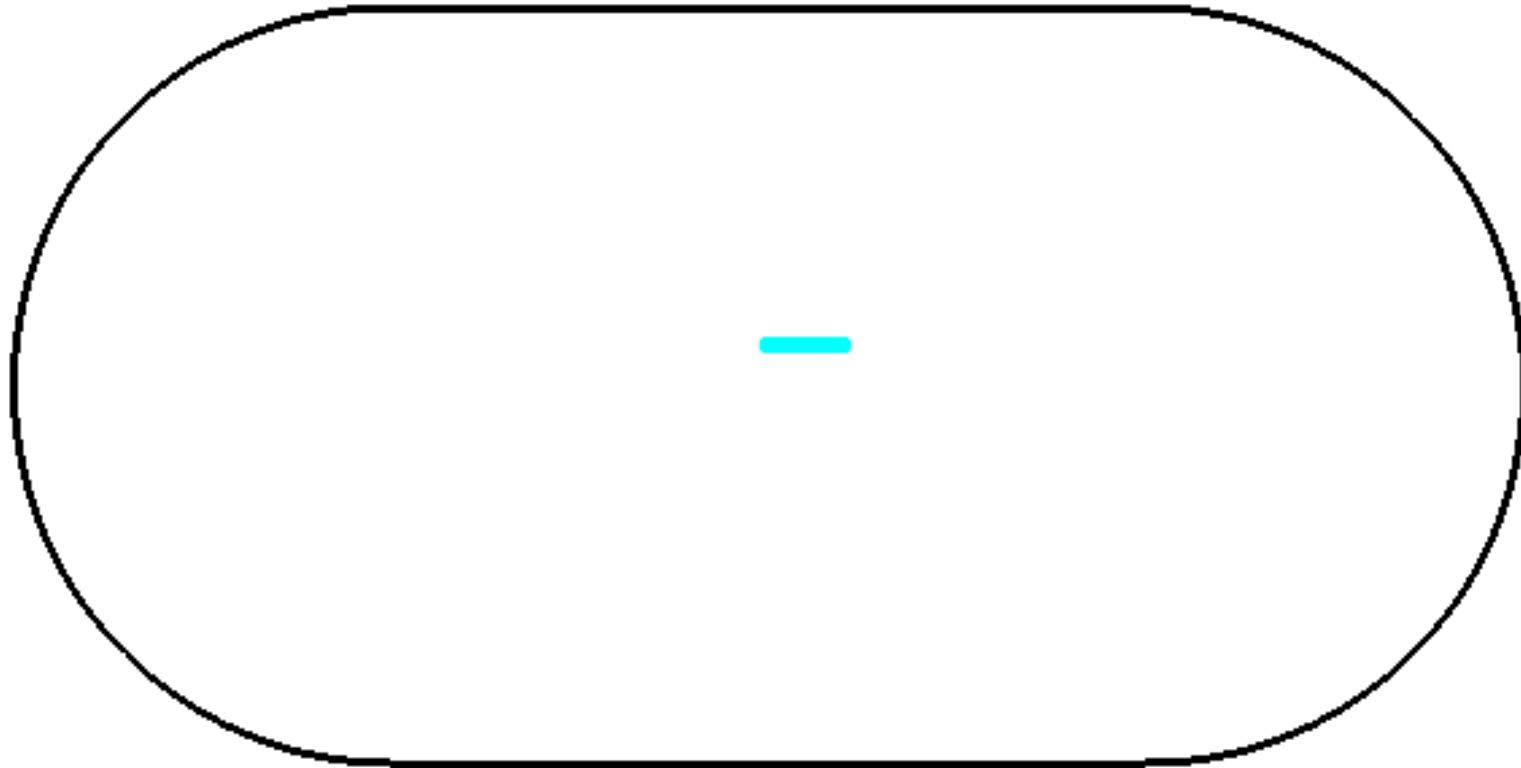

[Bunimovich stadium – simulation by Phillipe Roux,
<https://blogs.ams.org/visualinsight/2016/11/15/bunimovich-stadium/>]

Quantum scars

- Scars: wavefunctions exhibits features supported near classical periodic orbits in phase space (only most quantum states should be spread over whole space in semi-classical limit [[Shnirelman '74](#)])
- Experimental observation of long-lived oscillations in a presumably chaotic system [[51 Rydberg atoms: Bernien et al. '17](#)]
- Proposal: quantum “many-body” scars are special states in an exhibiting regular dynamics [[Turner-Michailidis-Abanin-Serbyn-Papic](#)]
- Considerable work, recent toy model: spin 1 chain [[Schechter-Iadecola](#)]

$$H = J \sum_{\langle ij \rangle} S_i^x S_j^x + S_i^y S_j^y + h \sum_i S_i^z + D \sum_i (S_i^z)^2 \quad J^\pm = \frac{1}{2} \sum_i e^{i\vec{r}_i \cdot \vec{\pi}} (S_i^\pm)^2$$

act on all down state

Experiments

PHYSICS TODAY

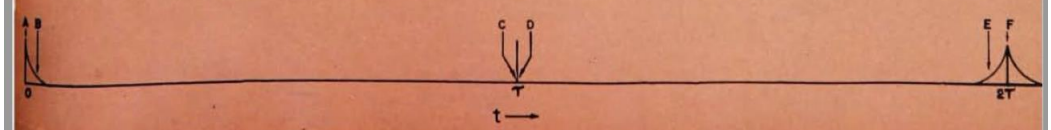
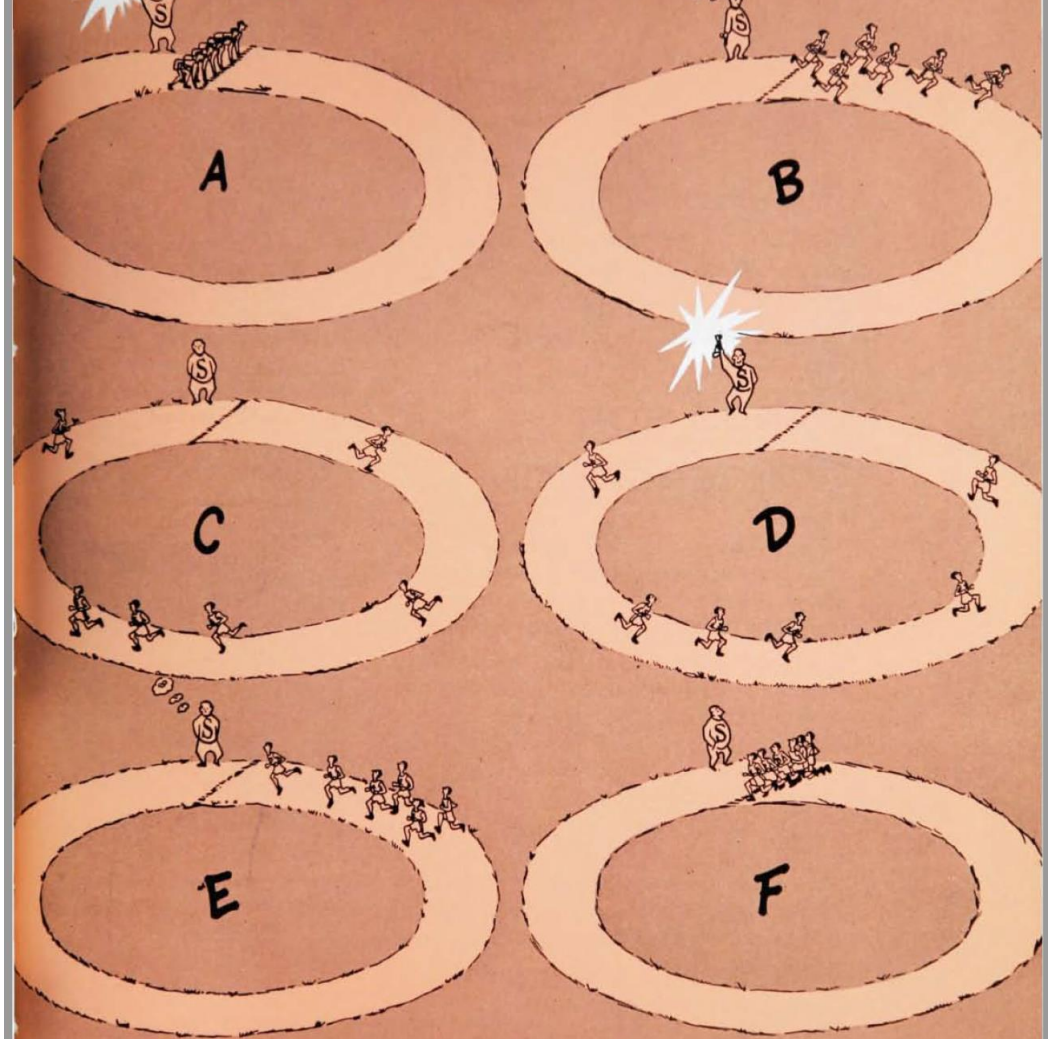
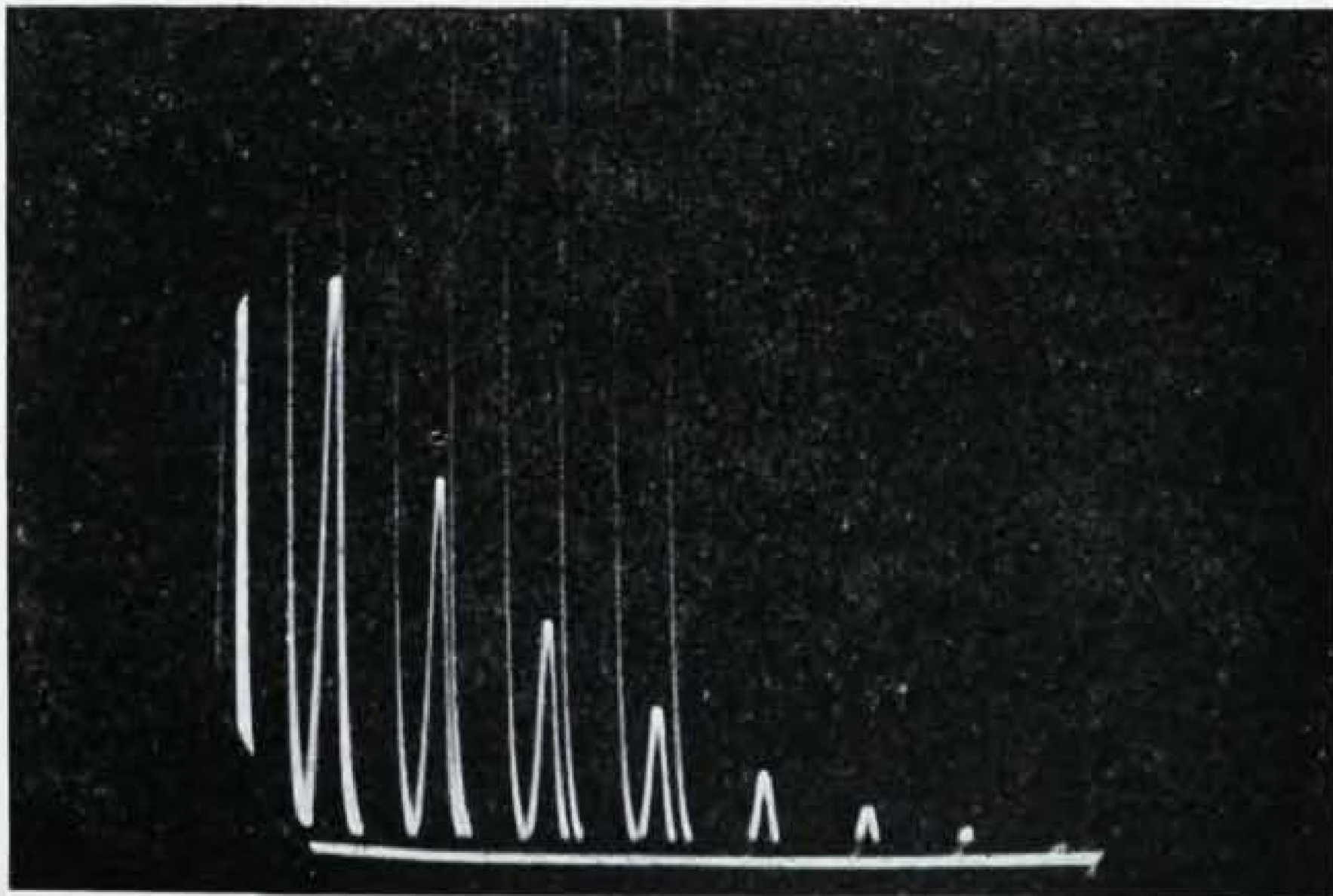

Fig. 6. Multiple exposures of single proton echoes. The first rf pulse occurs at the beginning of the trace and the second pulse is spaced from the origin at equal intervals for each exposure with the sample at thermal equilibrium. The echo envelope provides a measure of the phase coherence parameter T_2 .



[spin echoes: Hahn 1950]

Direct measurement

$$F = \left[\langle \psi | W_t^\dagger V^\dagger \right] \left[W_t V | \psi \rangle \right]$$

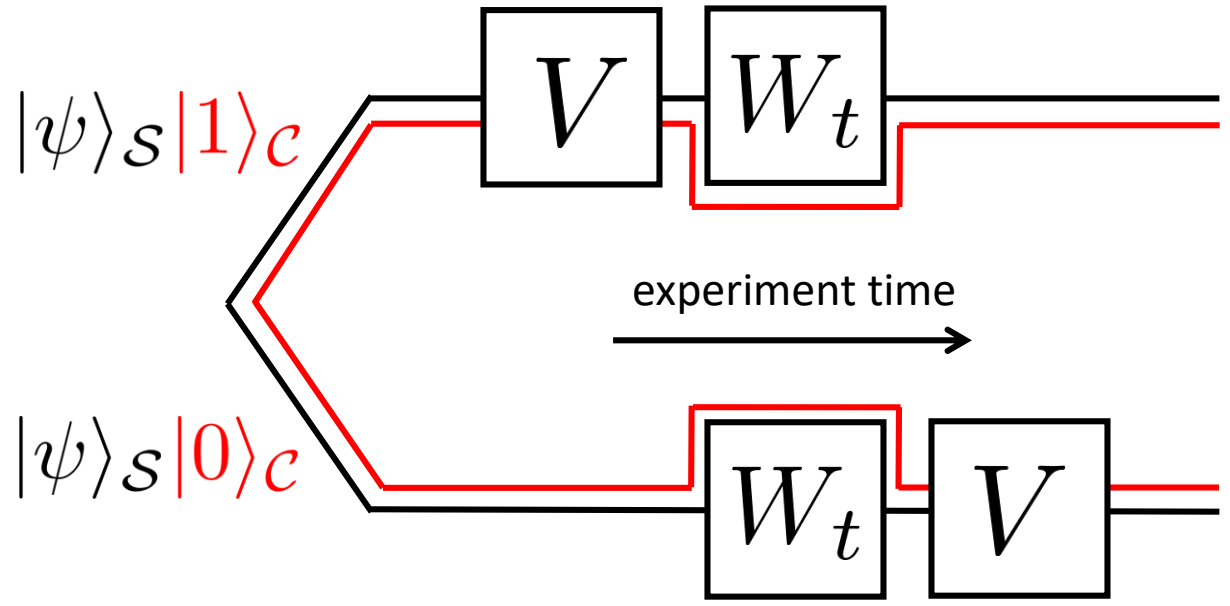
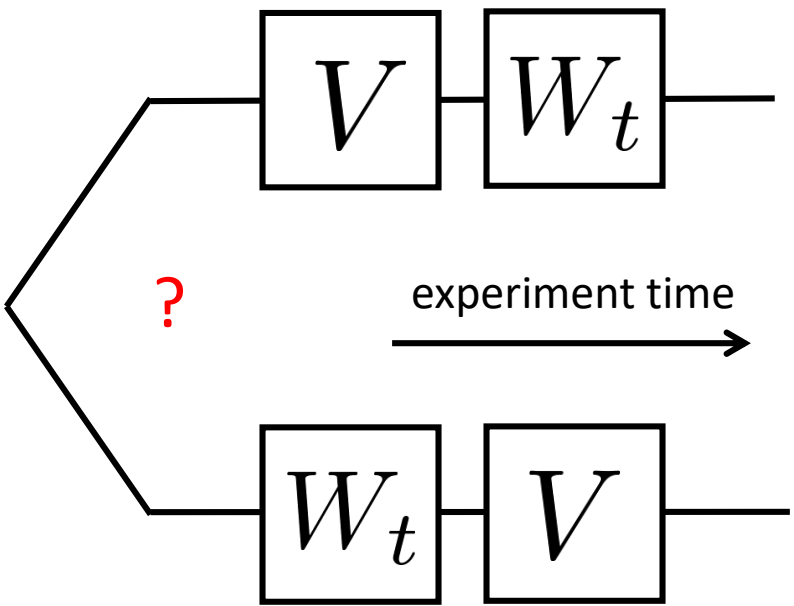
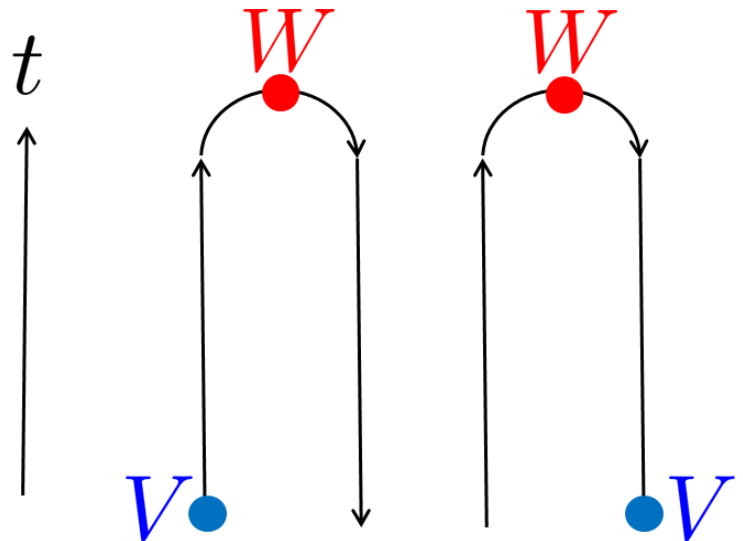

Additional protocols



- “Quantum clock” [Zhu-Hafezi-Grover ‘16]
 - Control qubit also controls direction of time; reduces some sources of error
- Purity-like measurement [Yao-Grusdt-S-Lukin-StamperKurn-Moore-Demler ‘16]
 - No time-reversal required, but must measure many-body overlap
- Weak measurement [Yunger Halpern ‘16, Yunger Halpern-S-Dressel ‘17]
- Decoding approach [Yoshida-Kitaev ‘17]
- Non-eq thermo [Campisi-Goold ‘16]
- Random fluctuations [Zoller et al., Qi et al.]
 - Exponentially many measurements and exponentially small signals

Exploring Localization in Nuclear Spin Chains

[PRL 120.7 (2018): 070501]

Ken Xuan Wei, Chandrasekhar Ramanathan, Paola Cappellaro

(Submitted on 15 Dec 2016)

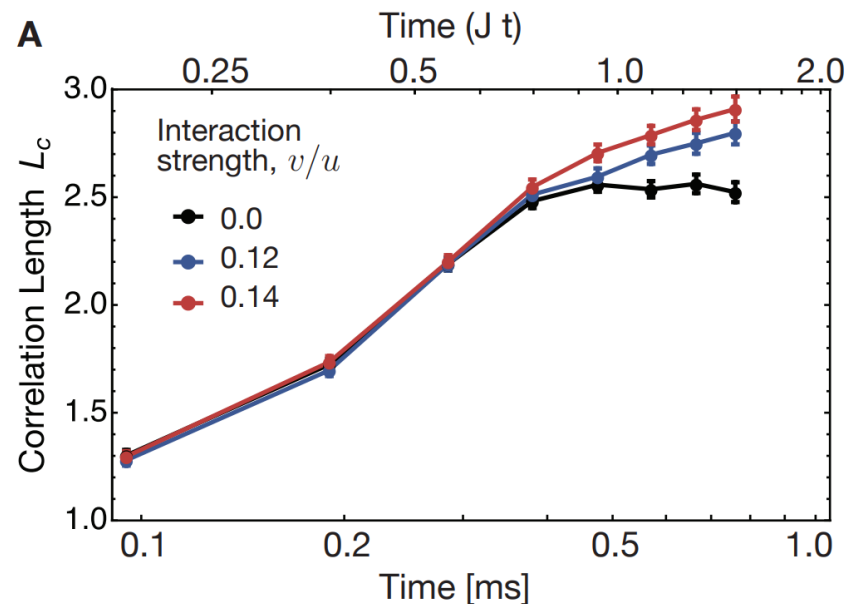
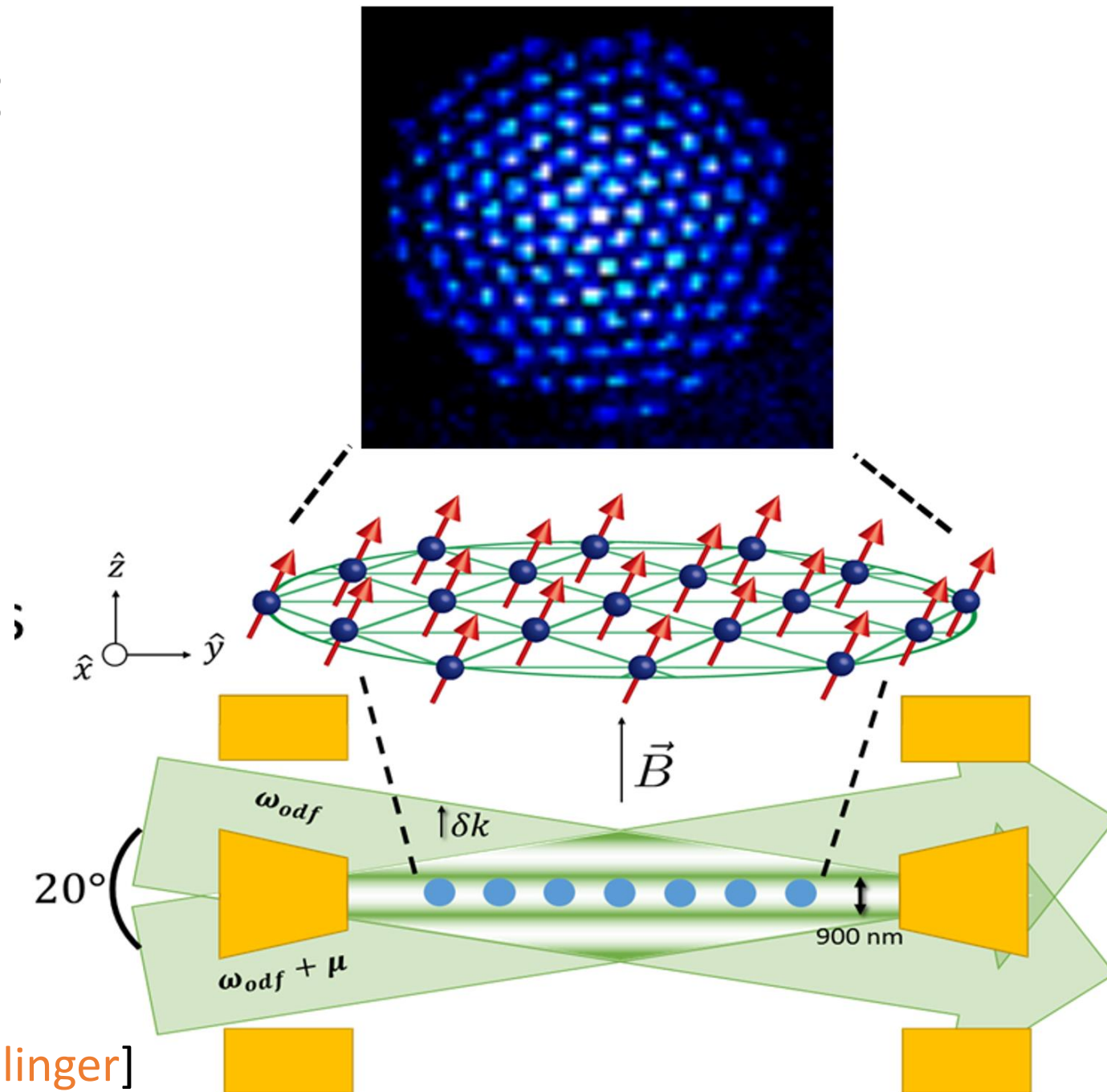

FIG. 3. **A: Experimental measurements of spin correlations in interacting spin chains.** We plot in log-linear scale the measured L_c dynamics in the presence of disorder and for varying interaction strengths v . Data are for $u = 0.24$, $g = 0.12$, and $b = 0$. After an initial growth of correlations, L_c saturates for the non-interacting systems, while it shows a slow growth in the presence of interactions, thus indicating many-body localization. **B: Simulations of spin correlation and entanglement entropy.** We compare the entropy of the reduced half chain (solid lines, left axis) with the correlation length L_c (dotted lines, right axis) and the approximate L_c obtained from measuring the MQC (dashed lines). The similar behavior (including logarithmic growth) confirm that the chosen metric is as good an indicator of MBL as the more commonly used entanglement entropy. Here we renormalized the entanglement entropy to vary between 0 and 1, see SM for details.

Ion trap:



[Courtesy of John Bollinger]

Quantum Information Dynamics

Communication vs information spreading

- Weakly coupled degrees of freedom can be used to transmit information in a locally accessible way, e.g. electromagnetic wave
- Strongly coupled degrees of freedom typically do not transmit information in locally accessible form
- Information spread can be measured by tracking entanglement with a reference:

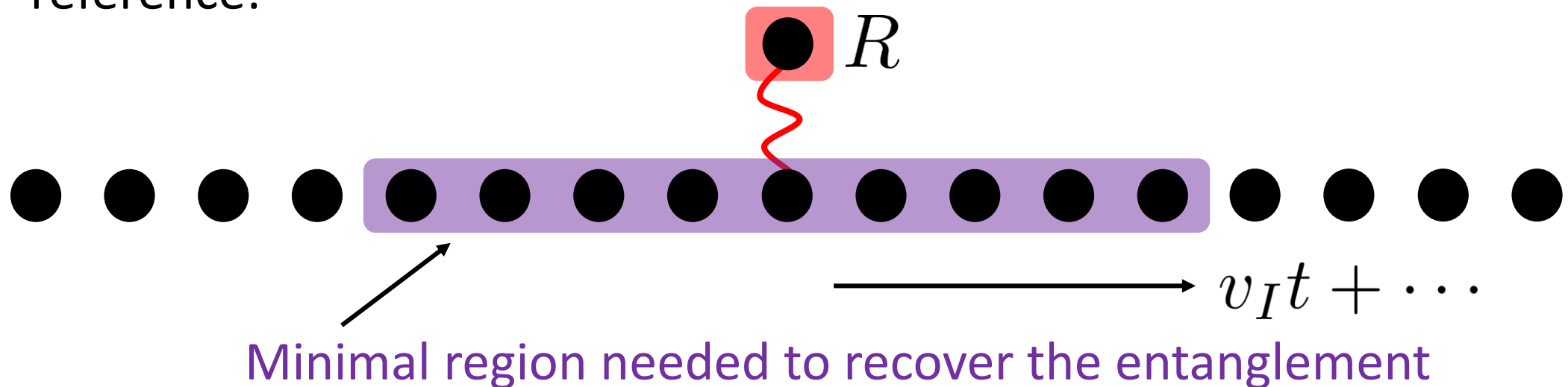

Quantum information model and result

- Consider initial out-of-equilibrium state with energy density \mathcal{E} and entanglement fraction f :
- Entanglement growth: $S(A) = \min\{fs|A| + sv_E|\partial A|t, s|A|\}$
- Operator spreading: v_B
- **Result: information velocity** $v_I = \min\left\{\frac{v_E}{1-f}, v_B\right\}$
[Eccles-Couch-Nguyen-S-Xu coming soon]
- **Argument idea: generalization of Hayden-Preskill; track which regions are maximally entangled and have access to scrambled output**

Evidence

- Spin chain calculations made by exact diagonalization; holographic calculations made by tracking motion of entangled particles
- Results:
 - Spin chain $f=0$ and $f=1$ limits clear, significant finite size effects
 - Partial results from black hole with null shell (generalizes [Mezei-Stanford])
- Comments:
 - Approach unifies various velocities in one simple setting
 - Gives new understanding of entanglement wedge dynamics
 - Decoding: traversable wormhole story [Gao-Jafferis-Wall, Maldacena-Stanford-Yang] generalizes to local systems

Toy model of external dynamics of black hole

- Let's setup a computational toy model of the outside dynamics of a black hole (Shor's model aka optical metric)
- Black hole has a characteristic time \mathcal{T} and coarse-grained entropy S
- Rules:
 - Break the spacetime up into cells defined by requiring the time for light to cross the cell is order \mathcal{T}
 - A calculation shows that each cell holds $O(1)$ bits (or qubits) of entropy arising from thermal excitations
 - We declare ignorance about the quantum gravity dynamics of the black hole except that they are bounded by the motion of light in black hole spacetime

Innermost layer has $O(S)$ cells

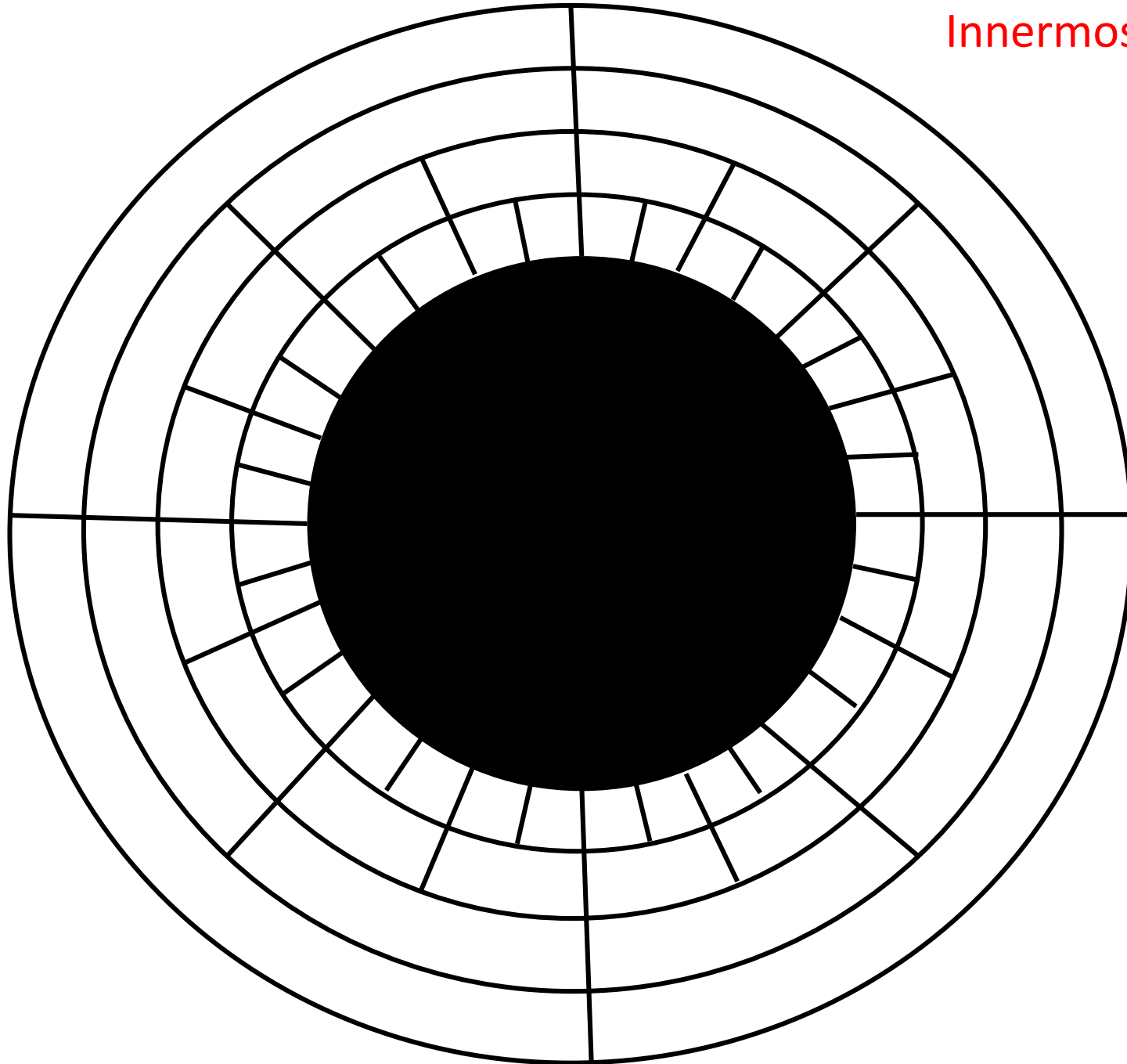

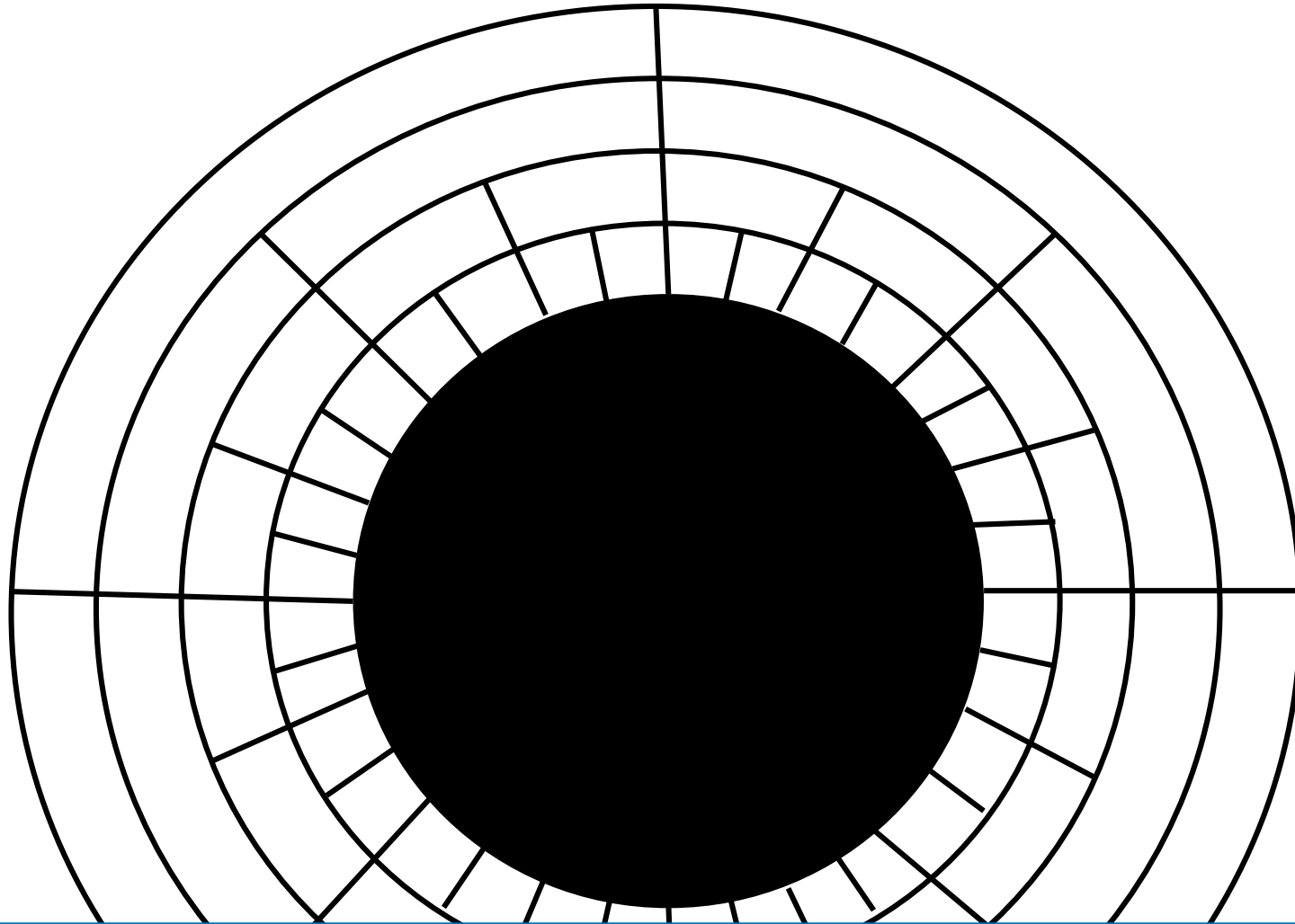

Bounds [Shor]:

- Weak scrambling (= mixing $O(1)$ qubits) is possible in time $\tau \log S$
- Strong scrambling (= generating nearly maximal entanglement) takes at least time τS (or $\tau S^\#$)

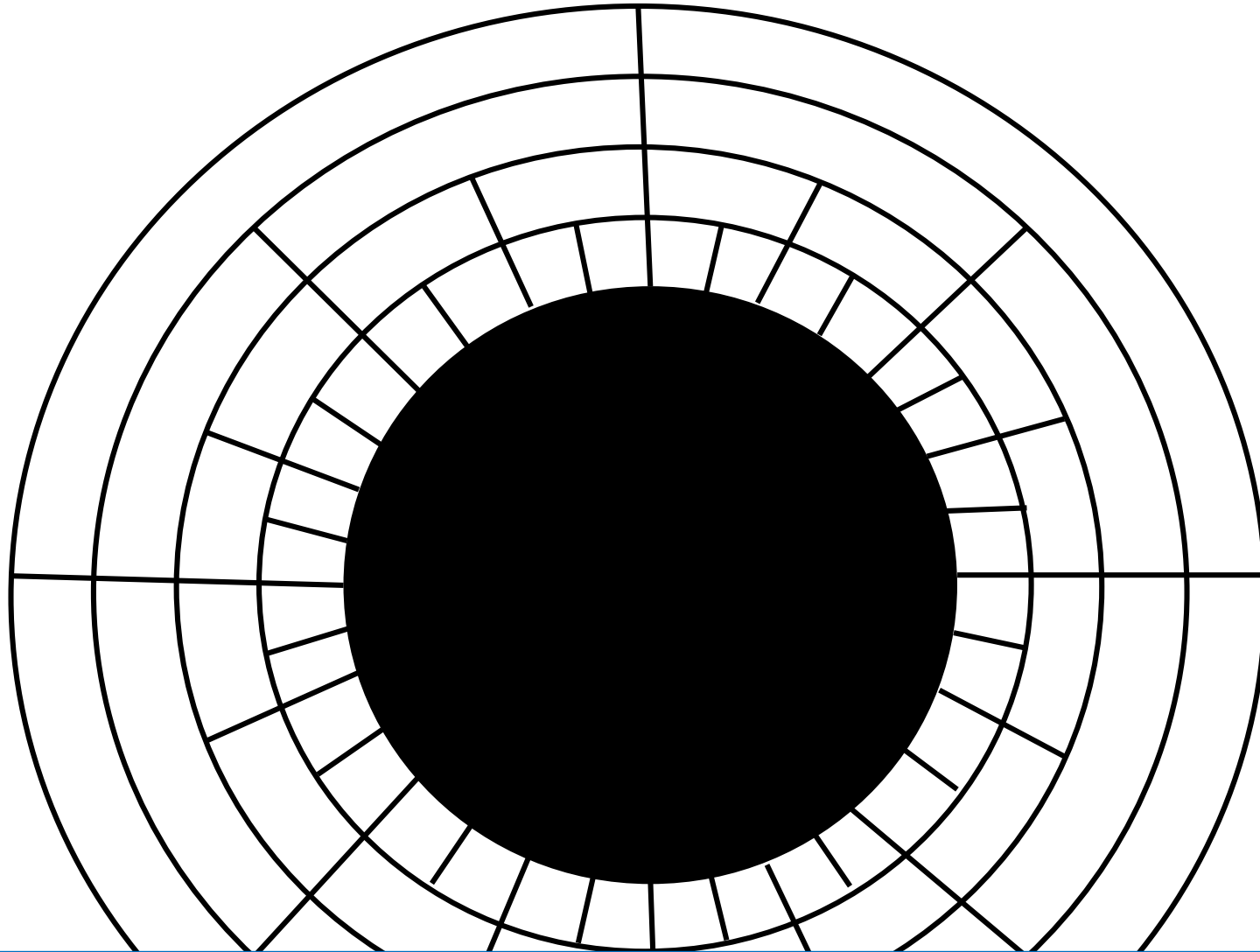

Challenge:

- Calculations with particular model (AdS/CFT) show that the both the weak and strong scrambling times are bounded by $\tau \log S$ [Cooper-...-S, Hartman-Maldacena]

Chaos-protected locality:

Hawking radiation
(simple, e.g. photons)

Horizon DOFs (complex)

SIGNAL

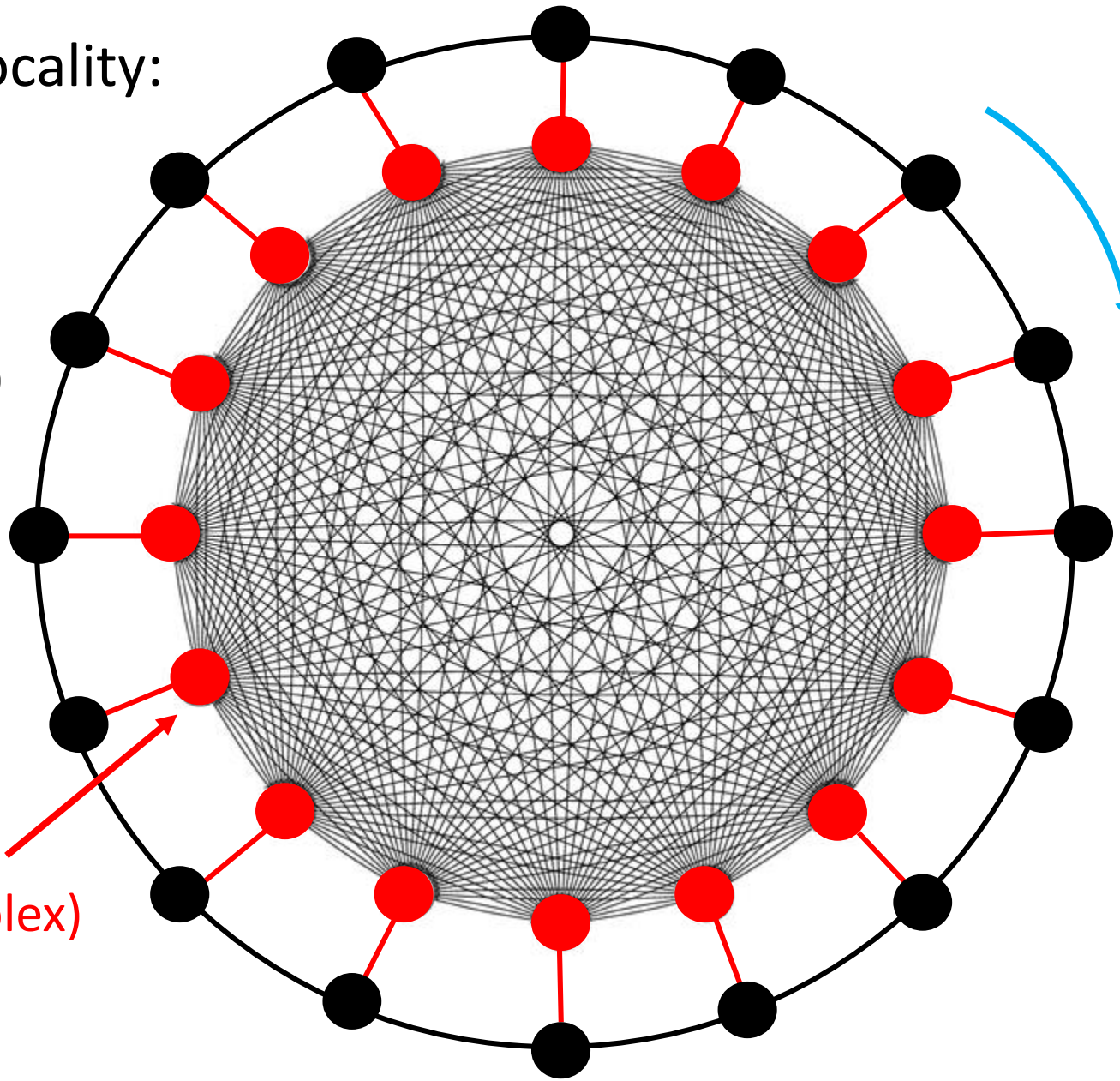

Sachdev-Ye-Kitaev model: violations of locality are suppressed by system size [S: coming soon]

Summary

- Quantum chaos and information scrambling are extremely active fields at present, and a new era of experimental input is coming soon
- In my personal opinion, we should expect surprises
- Research is still largely divided between short and long times, and connections between them are needed
- Two results from my group
 - Information speed and its relation to entanglement and butterfly velocities
 - Chaos-protected locality and possible applications to black holes

Addendum: references and additional topics